

# MARK MISTRAL MDX 56

0662070\_R02





# READ THIS DOCUMENT BEFORE INSTALLING THE HEATER

## **Warning**

Incorrect installation, adjustment, alteration, repair or maintenance work may lead to material damage or injury. All work must be carried out by certified, qualified professionals. If the appliance is not positioned in accordance with the instructions, the warranty shall be rendered void. This appliance is not intended for use by children or persons with a physical, sensory or mental handicap, or who lack the required experience or expertise, unless they are supervised or have been instructed in the use of the appliance by somebody who is responsible for their safety. Children must be supervised to ensure that they do not play with the appliance.

EN

## **1 General**

### **1.1 Application**

Appliance type MISTRAL MDX 56 is solely suitable for the free and direct intake of the air to be heated and the free discharge of heated air into the room. If areas are to be heated in which corrosive vapours are present (chlorinated hydrocarbons in particular), which are either produced directly in the area, or which may be drawn in from the outside by the heater via a duct or an open connection, wall air heaters cannot be used because of the risk of corrosion to the heat exchanger.

#### *Subject to change*

The manufacturer is committed to constantly improving its products and reserves the right to make changes in the specifications without prior notice. The technical details are considered correct but do not form the basis for a contract or warranty. All orders are accepted according to the standard terms of our general sales and delivery conditions (available upon request). The information in this document is subject to change without notice. The most recent version of this manual is always available at **[www.markclimate.com/downloads](http://www.markclimate.com/downloads)**.

### **1.2 General warnings**

Incorrect installation, adjustment, alteration, maintenance or repair of the MISTRAL MDX may lead to material or environmental damage and/or injuries. The appliance should therefore be installed, adapted or converted by a qualified and certified installer, taking into account national and international regulations. Faulty installation, adjustment, alteration, maintenance activity or repair shall render the warranty void.

## 2 Technical specifications

### 2.1 Technical specifications

Type			MDX 56
<b>Power</b>		<b>HP</b>	<b>20</b>
heating	Nominal capacity <sup>2</sup>	kW	63,0
	Absorbed power <sup>2</sup>	kW	19,21
	Nominal capacity <sup>3</sup>	kW	51,6
	Absorbed power <sup>3</sup>	kW	22,83
	SCOP		4,31
cooling	Nominal capacity <sup>1</sup>	kW	56
	Absorbed power <sup>1</sup>	kW	32,2
	EER <sup>1</sup>		1,74
<b>Electrical data</b>			
Power supply		Ph/V/Hz	3/380-415/50
Nominal Consumed current		A	35,0
Maximum current		A	45,9
Fuse		A	50
<b>Refrigerant features</b>			
Refrigerant			R410A
Quantity refrigerant pre-load <sup>4</sup>		kg	17 <sup>5</sup>
DC Inverter compressor		no. / type	2 / Scroll DC Inverter
Pipe connections	Liquid	inch	5/8"
	Gas	Ø mm	28
Distance indoor and outdoor unit	min	m	2
	max	m	170
Max height difference		m	90
<b>Specifications outdoor unit</b>			
Dimensions (LxHxD)		mm	1340x1635x825
Net weight		kg	344
Sound pressure level (5 mtr.)	max	dB(A)	52
Air flow	max	m <sup>3</sup> /h	17000
Operating limits (outside temperature)	Cooling	°C	-5 ~ +48
	Heating	°C	-23 ~ +24

<sup>1</sup> Indoor air temperature 27°C DB, 19°C WB; outdoor air temperature 35°C DB; equivalent refrigerant piping length 7.5m with zero level difference.

<sup>2</sup> Indoor air temperature 20°C DB, 19°C WB; outdoor air temperature 7°C DB, 6°C WB; equivalent refrigerant piping length 7.5m with zero level difference.

<sup>3</sup> Indoor air temperature 16°C DB, 19°C WB; outdoor air temperature -19,8°C DB, -20°C WB; equivalent refrigerant piping length 7.5m with zero level difference.

<sup>4</sup> Excl. refill liquid pipe

<sup>5</sup> Factory fill 11,8 kg. Refill on location 5,2 kg.

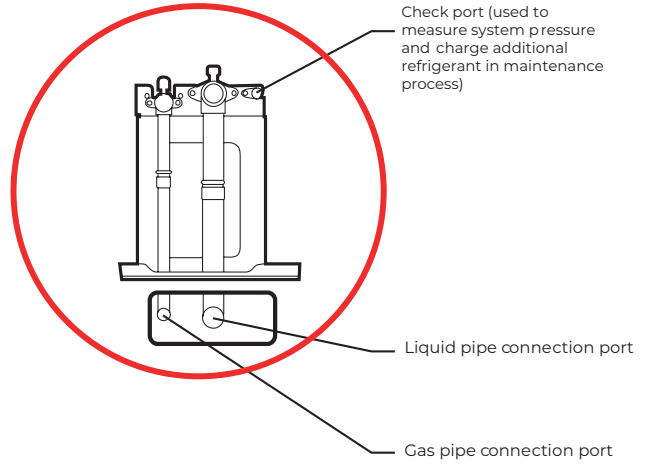
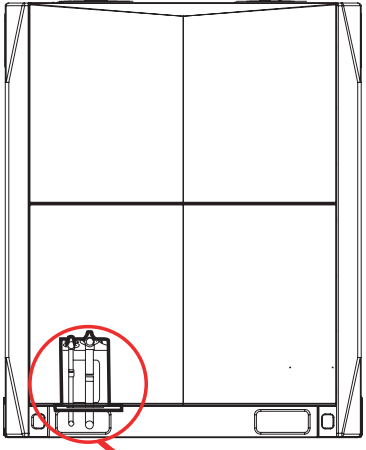
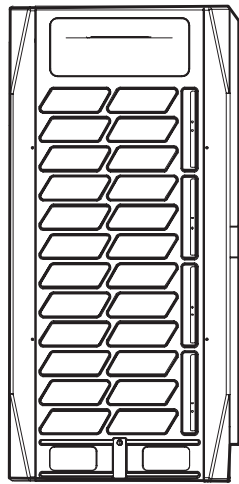
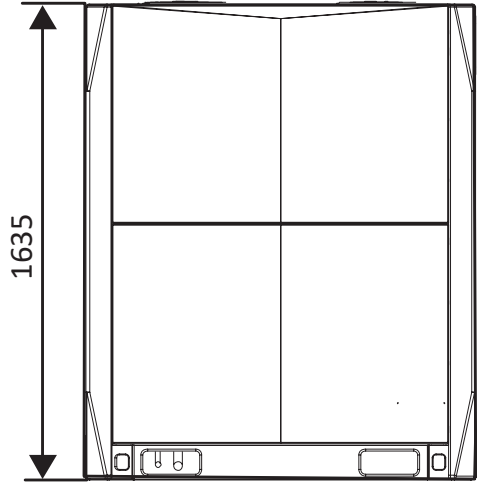
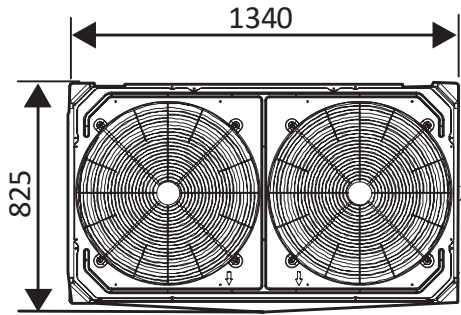

## 2.2 Heating capacities

Outdoor air temp.		Indoor air temp. °C DB											
		≤ 16		18		20		21		22		24	
		TC	PI	TC	PI	TC	PI	TC	PI	TC	PI	TC	PI
°C DB	°C WB	kW	kW	kW	kW	kW	kW	kW	kW	kW	kW	kW	kW
-25	-25.4	49.31	22.83	49.11	23.06	48.91	23.19	48.91	23.45	48.91	23.59	48.71	23.89
-19.8	-20	51.60	22.83	51.40	23.08	51.20	23.34	51.20	23.47	51.20	23.61	51.00	23.73
-18.8	-19	52.40	22.89	52.20	23.14	52.00	23.39	52.00	23.50	52.00	23.64	51.80	23.54
-16.7	-17	53.20	22.92	53.00	23.17	53.00	23.42	52.80	23.56	52.80	23.70	52.60	23.42
-13.7	-15	54.00	22.97	53.80	23.20	53.80	23.47	53.60	23.59	53.60	23.73	53.40	23.14
-11.8	-13	54.80	23.00	54.60	23.25	54.60	23.50	54.40	23.64	54.40	23.75	53.40	22.88
-9.8	-11	55.20	23.03	55.20	23.28	55.00	23.53	55.00	23.64	54.80	23.78	53.40	22.85
-9.5	-10	55.60	23.06	55.40	23.28	55.40	23.59	55.20	23.67	55.20	23.81	53.40	22.66
-8.5	-9.1	56.20	23.08	56.20	23.31	56.00	23.66	55.80	23.70	55.80	23.84	53.40	22.31
-7	-7.6	60.60	23.11	60.40	23.32	60.40	24.14	60.20	24.56	58.20	23.36	53.40	22.23
-5	-5.6	61.40	23.14	61.20	23.33	61.20	23.58	60.60	23.87	58.20	22.67	53.40	21.61
-3	-3.7	62.60	23.17	62.40	23.34	62.40	22.81	60.60	22.49	58.20	21.95	53.40	20.90
0	-0.7	64.20	23.20	67.80	23.36	63.00	22.17	60.60	21.47	58.20	20.87	53.40	19.98
3	2.2	68.40	22.73	67.80	22.78	63.00	21.54	60.60	20.42	58.20	19.63	53.40	19.00
5	4.1	72.60	22.37	67.80	21.66	63.00	20.52	60.60	19.50	58.20	18.83	53.40	18.16
7	6	72.60	22.09	67.80	20.55	63.00	19.21	60.60	18.46	58.20	18.07	53.40	17.36
9	7.9	72.60	20.83	67.80	19.46	63.00	18.68	60.60	18.01	58.20	17.53	53.40	16.80
11	9.8	72.60	19.49	67.80	18.27	63.00	18.06	60.60	17.28	58.20	16.89	53.40	16.10
13	11.8	72.60	18.27	67.80	17.81	63.00	17.36	60.60	16.67	58.20	16.29	53.40	15.55
15	13.7	72.60	17.38	67.80	17.06	63.00	16.72	60.60	16.08	58.20	15.71	53.40	14.94

Correction factor for frost accumulation

Heat exchanger temperature (°C / RH 85%)	-7	-5	-2	0	2	5	7
Correction factor for frost accumulation	0.94	0.93	0.89	0.84	0.83	0.91	1.00

## 2.3 Cooling capacities

Outdoor temperature (°C DB)	Indoor temperature (°C DB/WB)													
	DB:20.8; WB:14		DB:23.3; WB:16		DB:25.8; WB:18		DB:27; WB:19		DB:28.2; WB:20		DB: 30.7; WB:22		DB:32; WB:24	
	TC	PI	TC	PI	TC	PI	TC	PI	TC	PI	TC	PI	TC	PI
	kW	kW	kW	kW	kW	kW	kW	kW	kW	kW	kW	kW	kW	kW
-5	37.8	10.75	45.00	12.94	52.4	15.40	56.0	16.50	59.6	17.90	67.0	20.40	70.8	21.29
-2	37.8	10.88	45.00	13.11	52.4	15.57	56.0	16.80	59.6	18.14	67.0	20.64	70.8	21.42
0	37.8	10.99	45.00	13.24	52.4	15.74	56.0	17.01	59.6	18.31	67.0	20.98	70.8	21.66
2	37.8	11.20	45.00	13.43	52.4	15.91	56.0	17.23	59.6	18.51	67.0	21.29	70.8	22.01
4	37.8	11.29	45.00	13.55	52.4	16.15	56.0	17.49	59.6	18.75	67.0	21.49	70.8	22.24
6	37.8	11.45	45.00	13.83	52.4	16.36	56.0	17.80	59.6	19.03	67.0	21.80	70.8	22.59
8	37.8	11.67	45.00	14.03	52.4	16.66	56.0	18.00	59.6	19.34	67.0	22.14	70.8	22.96
10	37.8	11.81	45.00	14.30	52.4	16.93	56.0	18.31	59.6	19.70	67.0	22.51	70.8	23.29
12	37.8	11.99	45.00	14.58	52.4	17.25	56.0	18.63	59.6	20.06	67.0	22.92	69.8	23.47
14	37.8	12.22	45.00	14.85	52.4	17.57	56.0	19.00	59.6	20.43	67.0	23.38	69.0	23.76
16	37.8	12.45	45.00	15.13	52.4	17.94	56.0	19.37	59.6	20.85	66.6	23.66	68.0	24.03
18	37.8	12.68	45.00	15.40	52.4	18.26	56.0	19.74	59.6	21.26	65.8	24.45	67.2	24.63
20	37.8	12.92	45.00	15.73	52.4	18.82	56.0	20.75	59.6	22.79	64.8	25.60	66.2	25.83
21	37.8	13.05	45.00	15.87	52.4	19.51	56.0	21.49	59.6	23.57	64.4	26.20	65.8	26.43
23	37.8	13.37	45.00	16.93	52.4	20.89	56.0	23.02	59.6	25.27	63.6	27.40	64.8	27.63
25	37.8	14.25	45.00	18.08	52.4	22.37	56.0	24.67	59.6	27.07	62.6	28.60	64.0	28.83
27	37.8	15.22	45.00	19.28	52.4	23.89	56.0	26.38	59.6	28.97	61.6	29.79	63.0	30.07
29	37.8	16.19	45.00	20.57	52.4	25.51	56.0	28.18	59.4	30.76	60.8	31.04	62.2	31.27
31	37.8	17.25	45.00	21.95	52.4	27.21	56.0	30.07	58.6	31.96	59.8	32.24	61.2	32.52
33	37.8	18.31	45.00	23.38	52.4	29.01	56.0	32.10	57.6	33.16	59.0	33.44	60.4	33.76
35	37.8	19.46	45.00	24.86	52.4	30.95	56.0	34.22	56.6	34.36	58.0	34.68	59.4	34.96
37	37.8	20.71	45.00	26.47	52.4	32.98	55.0	35.42	55.8	35.61	57.2	35.92	58.4	36.21
39	37.8	22.00	45.00	28.13	52.4	35.10	54.2	36.62	54.8	36.81	56.2	37.13	57.6	37.50
41	37.8	23.03	45.00	29.16	52.4	36.38	53.4	36.88	54.4	37.37	55.2	38.00	56.8	38.27
43	37.8	24.05	45.00	30.19	52.4	37.06	52.5	37.31	54.0	37.73	55.6	38.25	55.8	38.70
45	37.8	25.42	45.00	31.56	52.4	37.69	51.4	37.82	53.7	38.42	55.1	38.84	54.6	39.21
48	37.8	26.54	45.00	32.66	52.4	37.75	49.3	38.25	53.6	39.10	51.7	39.24	53.4	39.58

CR: Combination ratio

TC: Total capacity (kW)

PI: Power input (compressor + outdoor fan motor (kW))

## 3 Unit Placement and Installation

### 3.1 Acceptance and unpacking

- » When units are delivered check whether any damage occurred during shipment. If there is damage to the surface or outside of a unit, submit a written report to the shipping company.
- » Check that the model, specifications and quantity of the units delivered are as ordered.
- » Check that all accessories ordered have been included. Retain the technical manual for future reference.

#### 3.1.1 Hoisting

- » Do not remove any packaging before hoisting. If units are not packaged or if the packaging is damaged, use suitable boards or packing material to protect the units.
- » Hoist one unit at a time, using two ropes to ensure stability.
- » Keep units upright during hoisting, ensuring that the angle to the vertical does not exceed 30°.

### 3.2 Placement

#### 3.2.1 Placement considerations

Placement of outdoor units should take account of the following considerations:

- » Air conditioners should not be exposed to direct radiation from a high-temperature heat source.
- » Air conditioners should not be installed in positions where dust or dirt may affect heat exchangers.
- » Air conditioners should not be installed in locations where exposure to oil or to corrosive or harmful gases, such as acidic or alkaline gases, may occur.
- » Air conditioners should not be installed in locations where exposure to salinity may occur unless the anti-corrosion treatment for high-salinity areas customization option has been added and the precautions described in Chapter 11 “Installation in Areas of High Salinity” are taken.
- » Outdoor units should be installed in well-drained, well-ventilated positions that are as close as possible to the indoor units.

#### 3.2.2 Spacing

Outdoor units must be spaced such that sufficient air may flow through each unit. Sufficient airflow across heat exchangers is essential for outdoor units to function properly. Figures 3.1 to 3.3 show spacing requirements in three different scenarios.

If the particular circumstances of an installation require a unit to be placed closer to a wall than specified in Figures 3.1 to 3.3, a discharge duct should be installed. Depending on the height of adjacent walls relative to the height of the units, ducting may be required. Refer to Chapter 4 “Outdoor Unit Ducting and Shielding”.

Figure 3.1 Single unit installation (unit: mm)

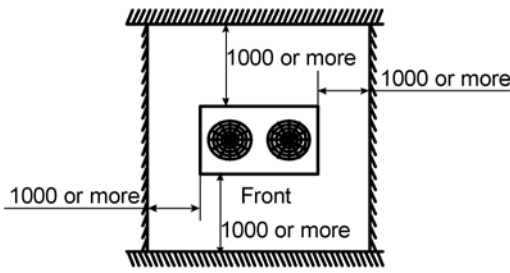

Figure 3.2 Single row installation (unit: mm)

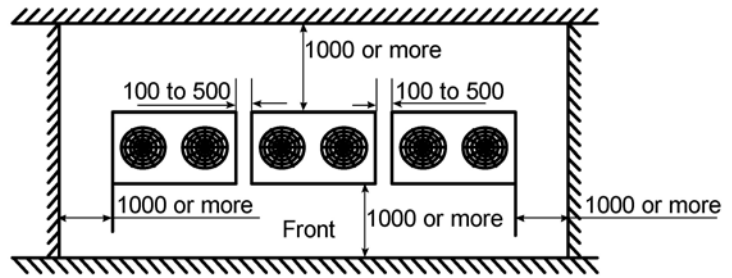
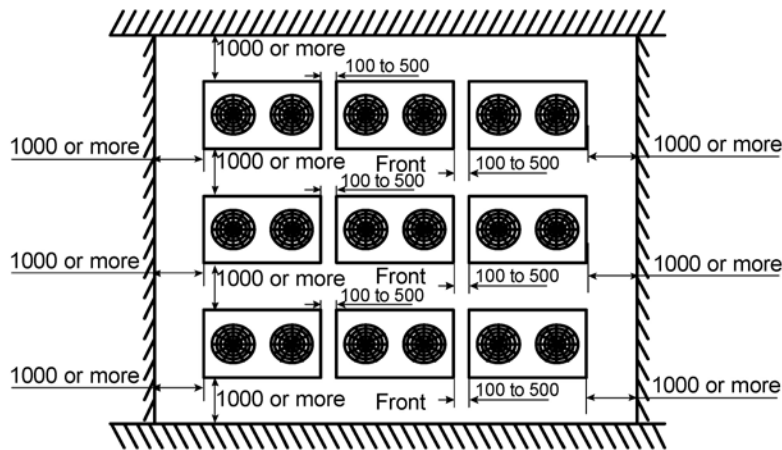

Figure 3.3 Multi-row installation (unit: mm)



### 3.2.3 Base structures

Outdoor unit base structure design should take account of the following considerations:

- » A solid base prevents excess vibration and noise. Outdoor unit bases should be constructed on solid ground or on structures of sufficient strength to support the units' weight.
- » Bases should be at least 200mm high to provide sufficient access for installation of piping.
- » Either steel or concrete bases may be suitable.
- » A typical concrete base design is shown in Figure 3.4. A typical concrete specification is 1 part cement, 2 parts sand and 4 parts crushed stone with Ø10mm steel reinforcing bar. The edges of the base should be chamfered.
- » To ensure that all contact points are equally secure, bases should be completely level. Bolt spacings should be as per Figure 3.5 and the corresponding table.
- » A drainage ditch should be provided to allow drainage of condensate that may form on the heat exchangers when the units are running in heating mode. The drainage should ensure that condensate is directed away from roadways and footpaths, especially in locations where the climate is such that condensate may freeze.



Figure 3.4 Outdoor unit typical concrete base structure design (unit: mm)

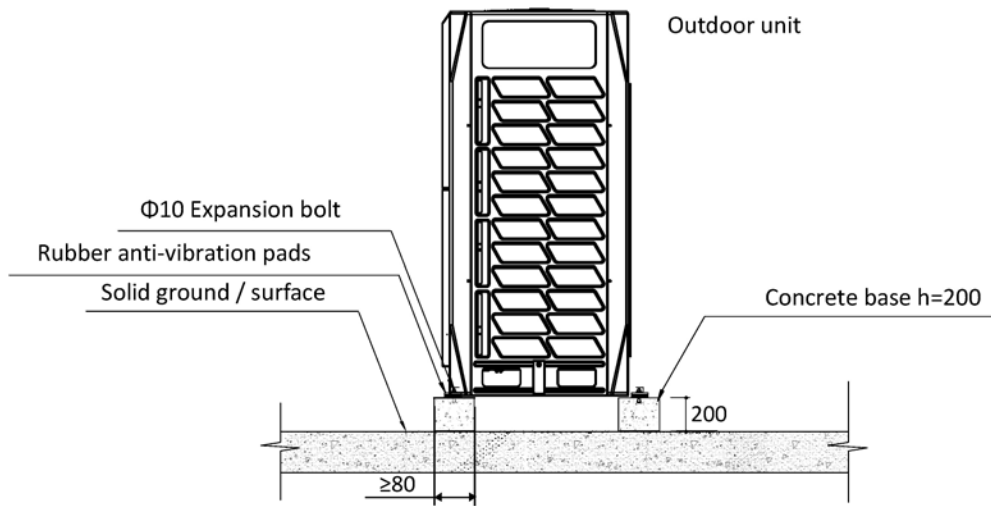
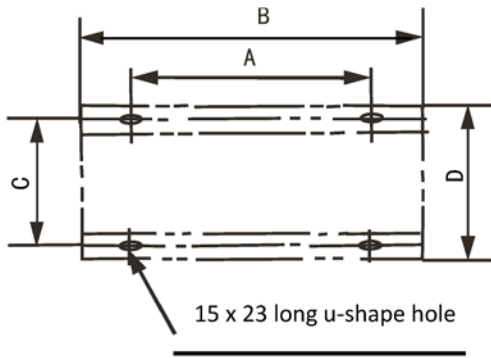

Figure 3.5 Expansion bolt positioning



Expansion bolt spacings (mm)

Expansion bolt spacings (mm)	
A	1090
B	1340
C	723
D	790

### 3.3 Indoor units

For placement of indoor units please see the technical manual of the indoor unit Mistral MDX.

## 4 Outdoor Unit Ducting and Shielding

### 4.1 Ducting Requirements

Depending on the height of adjacent walls relative to the height of the units, ducting may be required to ensure proper air discharge. In the situation depicted in Figure 4.1, the vertical section of ducting should be at least  $H-h$  high.

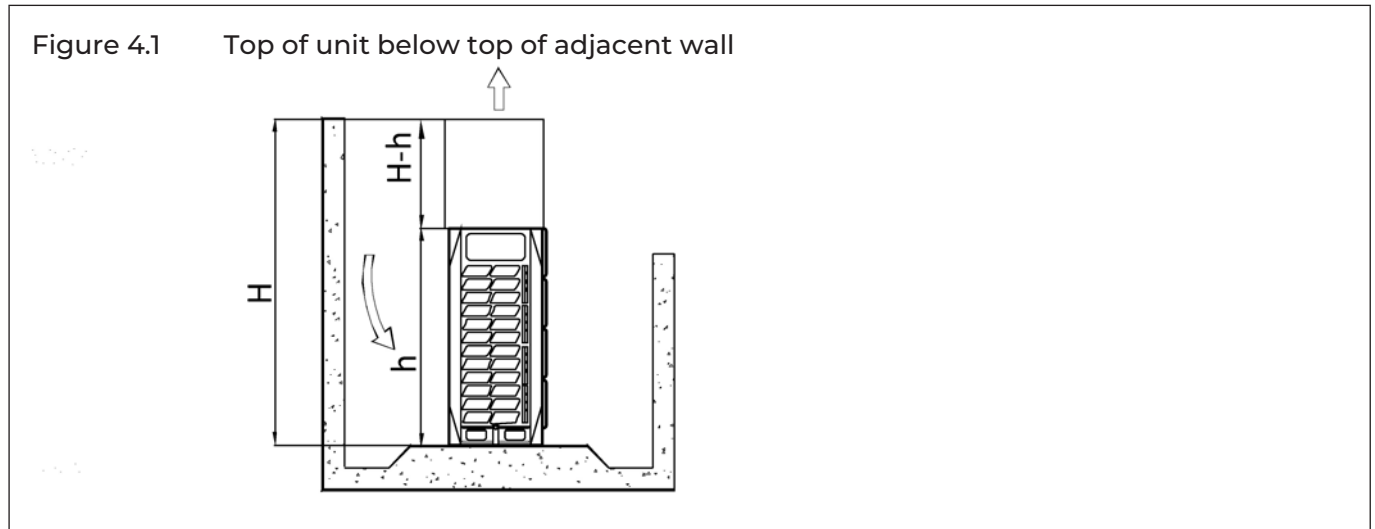

### 4.2 Design Considerations

Outdoor unit ducting design should take account of the following:

- » Each duct should contain no more than one bend.
- » Vibration isolation should be added to the connection between the unit and the ducting to avoid vibration/noise.
- » Installing louvers is required as doing for safety, they should be installed at an angle no greater than  $15^\circ$  to the horizontal, to minimize the impact on airflow.

### 4.3 Ducting

#### 4.3.1 Option A - Transverse ducting

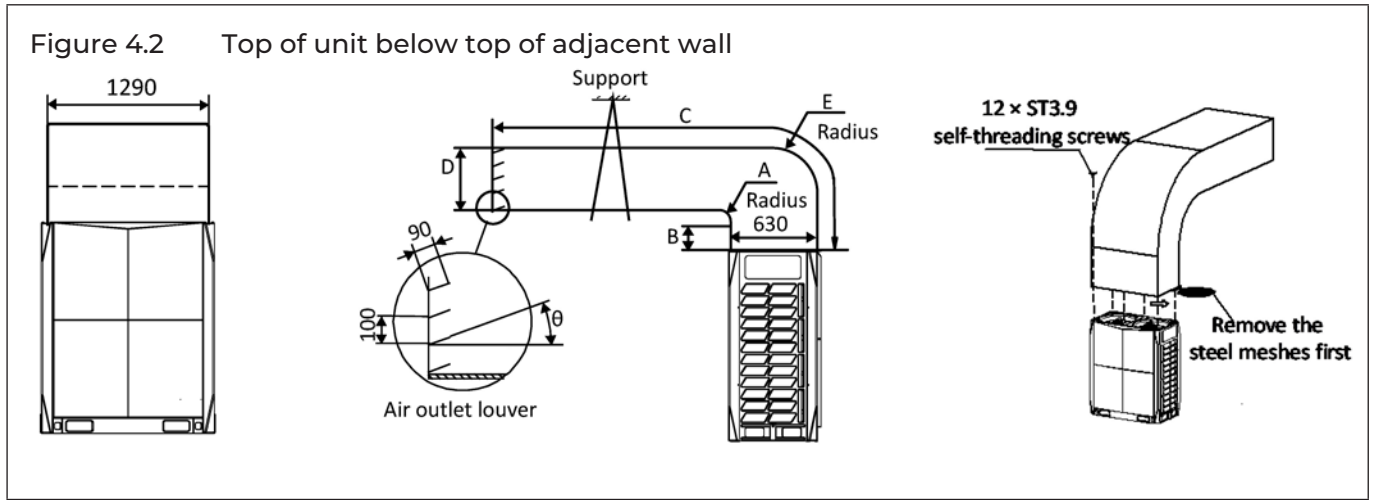

#### Duct dimensions

Dimensions (mm)	
A	$A > 300$
B	$B > 250$
C	$C < 3000$
D	$630 < D < 660$
E	$E = A + 630$
$\varnothing$	$\varnothing < 15^\circ$

#### External static pressure

ESP (Pa)	Remarks
0	Factory default
0 - 20	Remove steel mesh and connect to duct < 3m long
> 20	Customization option

#### 4.3.2 Option B – Longitudinal ducting

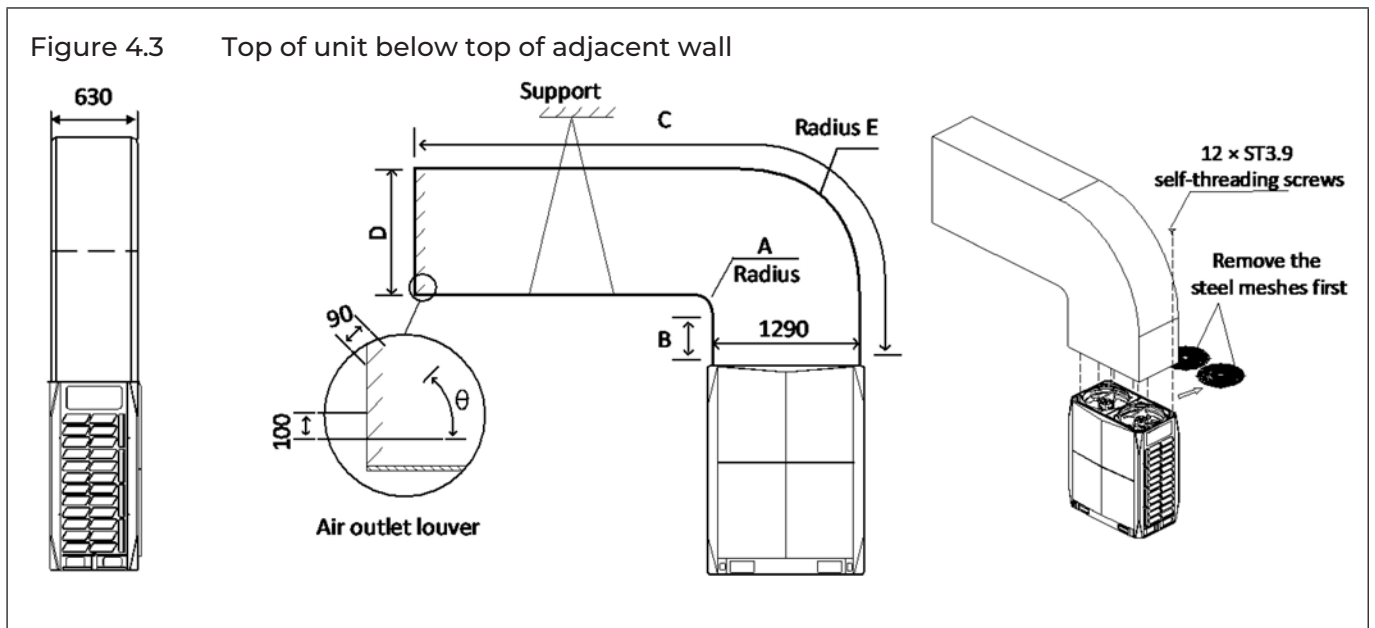

EN

### Duct dimensions

Dimensions (mm)	
A	A > 300
B	B > 250
C	C < 3000
D	D > 1290
E	E = A + 1290
Ø	Ø < 15°

### External static pressure

ESP (Pa)	Remarks
0	Factory default
0 - 20	Remove steel mesh and connect to duct < 3m long
> 20	Customization option

### 4.4 Fan Performance

The default external static pressure of outdoor units' air outlets is zero. With the steel mesh cover removed the external static pressure is 20Pa.

- » Before installing outdoor unit ducting, be sure to remove the unit's steel mesh cover, otherwise air flow will be adversely affected.

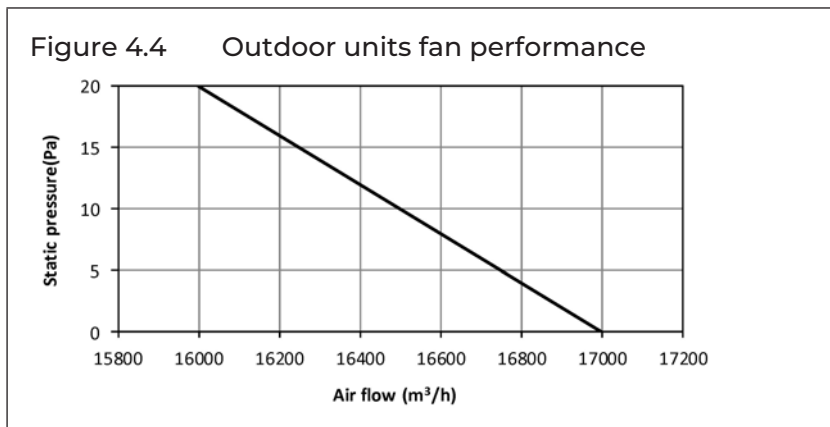

### 4.5 Snow Shielding

In areas of high snowfall, snow shields should be installed on air inlets and outlets to prevent snow from entering the units. Additionally, the height of the base structures should be increased so as to raise the units further off the ground.

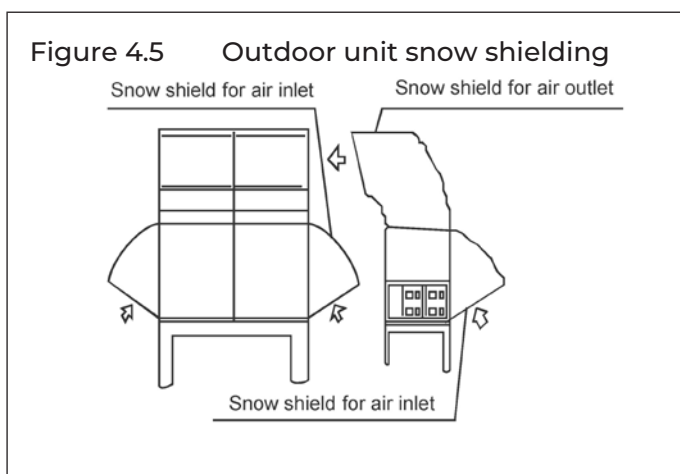

# 5 Refrigerant Piping Design

## 5.1 Design Considerations

Refrigerant piping design should take account of the following considerations:  
 » The amount of brazing required should be kept to a minimum.

## 5.2 Material Specification

Only seamless certified copper pipes with a minimum pressure resistance of 45 Bar may be used.

EN

## 5.3 Permitted Piping Lengths and Level Differences

The piping length and level difference requirements that apply are summarized in the table above and are fully described as follows:

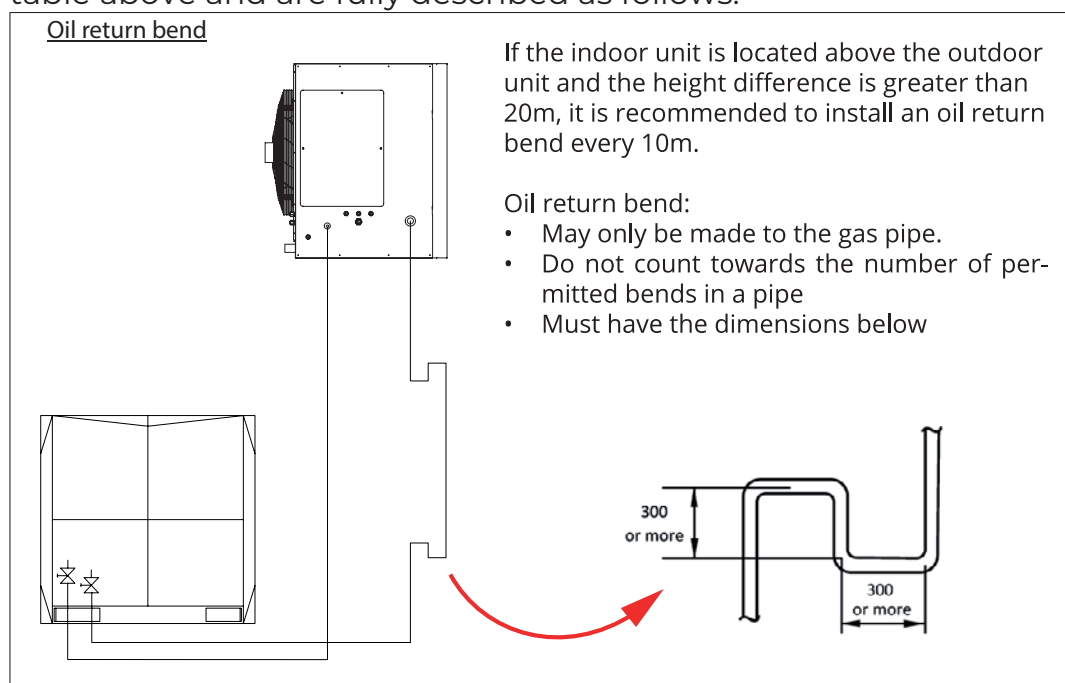

5.3.1 Permitted refrigerant piping length and level difference requirements for connecting to one indoor unit

The max height drop (m)		The length of refrigerant pipe (m)		The number of bends
Outdoor unit is higher than indoor unit	Outdoor unit is lower than indoor unit			
90	90	Min. 2	Max. 170	≤ 10

## 5.4 Refrigerant Leakage Precautions

R410A refrigerant is not flammable in air at temperatures up to 100°C at atmospheric pressure and is generally considered a safe substance to use in air conditioning systems. Nevertheless, precautions should be taken to avoid danger to life in the unlikely event of a major refrigerant leakage. Precautions should be taken in accordance with all applicable legislation. Where no applicable legislation exists, the following may be used as a guide:

- » Air conditioned rooms should be large enough that if leakage of all the refrigerant in the system occurs, the concentration of the refrigerant in the room does not reach a level dangerous to health.
- » A critical concentration (at which point R410A becomes dangerous to human health) of  $0.3 \text{ kg/m}^3$  can be used.
- » The potential concentration of refrigerant in a room following a leak can be calculated as follows:
  - Calculate the total amount in of refrigerant in the system (“A”) as the nameplate charge (the charge in the system when delivered from the factory) plus the additional charge added as per Chapter 9.1 “Calculating Additional Refrigerant Charge”.
  - Calculate the total volume (“B”) of the smallest room into which refrigerant could potentially leak.
  - Calculate the potential refrigerant concentration as A divided by B.
  - If  $A/B$  is not less than  $0.3 \text{ kg/m}^3$ , countermeasures such installing mechanical ventilators (either ventilating regularly or controlled by refrigerant leakage detectors) should be taken.
- » Since R410A is heavier than air, particular consideration should be given to leak scenarios in basement rooms.

**Figure 5.1** Potential refrigerant leak scenario

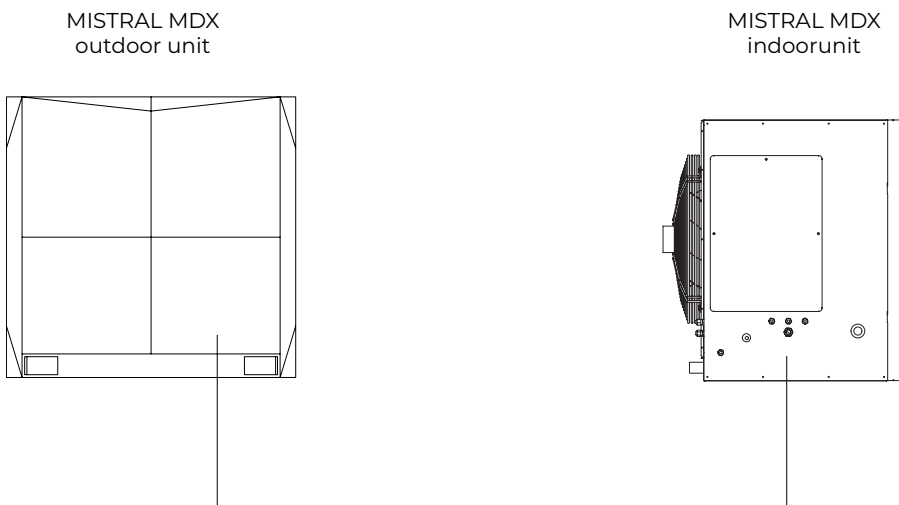
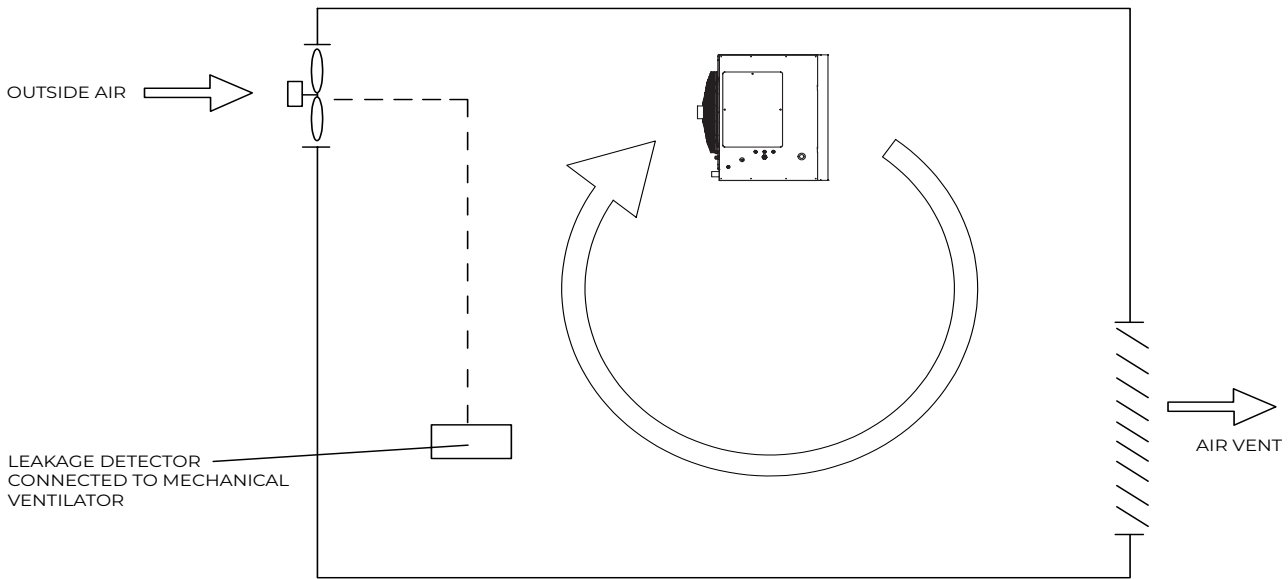

Figure 5.2 Mechanical ventilator controlled by refrigerant leak detector



## 6 Refrigerant Piping Installation

### 6.1 Procedure and Principles

#### 6.1.1 Installation procedure

Installation of the refrigerant piping system should proceed in the following order:



Note: Pipe flushing should be performed once the brazed connections have been completed with the exception of the final connections to the indoor units. That is, flushing should be performed once the outdoor unit have been connected but before the indoor units are connected.

#### 6.1.2 Three principles for refrigerant piping

	Reasons	Measures
CLEAN	Particles such as oxide produced during brazing and/or building dust can lead to compressor malfunction	<ul style="list-style-type: none"> <li>» Seal piping during storage<sup>1</sup></li> <li>» Flow nitrogen during brazing<sup>2</sup></li> <li>» Pipe flushing<sup>3</sup></li> </ul>
DRY	Moisture can lead to ice formation or oxidization of internal components leading to abnormal operation or compressor damage	<ul style="list-style-type: none"> <li>» Pipe flushing<sup>3</sup></li> <li>» Vacuum drying<sup>4</sup></li> </ul>
SEALED	Imperfect seals can lead to refrigerant leakage	<ul style="list-style-type: none"> <li>» Pipe manipulation<sup>5</sup> and brazing<sup>2</sup> techniques</li> <li>» Gas tightness test<sup>6</sup></li> </ul>

## Notes:

- <sup>1</sup> See 6.2.1 “Pipe delivery, storage and sealing”.
- <sup>2</sup> See 6.5 “Brazing”.
- <sup>3</sup> See 6.6 “Pipe Flushing”.
- <sup>4</sup> See 6.8 “Vacuum Drying”.
- <sup>5</sup> See 6.3 “Manipulating Copper Piping”.
- <sup>6</sup> See 6.7 “Gas tightness Test”.

## **6.2 Storing Copper Piping**

### *6.2.1 Pipe delivery, storage and sealing*

- » Ensure that piping does not get bent or deformed during delivery or whilst stored.
- » On construction sites store piping in a designated location.
- » To prevent dust or moisture entering, piping should be kept sealed whilst in storage and until it is about to be connected. If piping is to be used soon, seal the openings with plugs or adhesive tape. If piping is to be stored for a long time, charge the piping with nitrogen at 0.2-0.5MPa and seal the openings by brazing.
- » Storing piping directly on the ground risks dust or water ingress. Wooden support supports can be used to raise piping off the ground.
- » During installation, ensure that piping to be inserted through a hole in a wall is sealed to ensure dust and/ or fragments of wall do not enter.
- » Be sure to seal piping being installed outdoors (especially if being installed vertically) to prevent rain entering.

## **6.3 Manipulating Copper Piping**

### *6.3.1 De-oiling*

- » Lubrication oil used during some copper pipe manufacturing processes can cause deposits to form in R410A refrigerant systems, causing system errors. Oil-free copper piping should therefore be selected. If ordinary (oily) copper piping is used, it must be cleaned prior to installation.
- » **CAUTION!** Never use carbon tetrachloride (CCl<sub>4</sub>) for pipe cleansing or flushing, as doing so will seriously damage the system.

### *6.3.2 Cutting copper piping and removing burrs*

- » Use a pipe cutter rather than a saw or cutting machine to cut piping. Rotate the piping evenly and slowly, applying even force to ensure that the piping does not become deformed during cutting. Using a saw or cutting machine to cut piping runs the risk of copper shavings entering the piping. Copper shavings are difficult to remove and pose a serious risk to the system if they enter the compressor or block the throttling unit.
- » After cutting using a pipe cutter, use a reamer/scrapper to remove any burrs that have formed at the opening, keeping the opening of the piping downwards to avoid copper shavings from entering the piping.
- » Remove burrs carefully to avoid scratches, which may prevent a proper seal being formed and lead to refrigerant leakage.

### *6.3.3 Expanding copper piping ends*

- » Ends of copper piping can be expanded so that another length of piping can be inserted and the joint brazed.



- » Insert the expanding head of the pipe expander into the pipe. After completing pipe expansion, rotate the copper pipe a few degrees to rectify the straight line mark left by the expanding head.
- » **CAUTION!** Ensure that the expanded section of piping is smooth and even. Remove any burrs that remain after cutting.

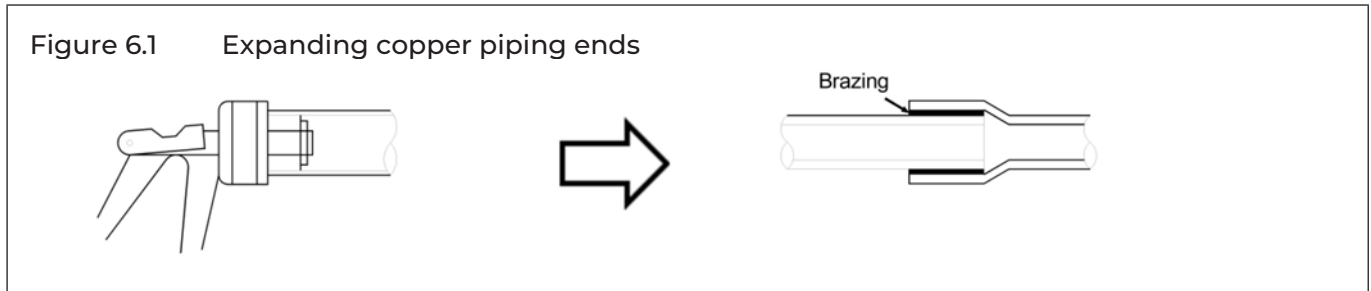

EN

### 6.3.4 Flared joints

Flared joints should be used where a screw thread connection is required.

- » Before flaring 1/2H (half hard) piping, anneal the end of the pipe to be flared.
- » Remember to place the flare nut on the piping before flaring.
- » Ensure the flared opening is not cracked, deformed or scratched, otherwise it will not form a good seal and refrigerant leakage may occur.
- » The diameter of the flared opening should be within the ranges specified in the table below. Refer to Figure 6.2.

Pipe (mm)	Flared opening diameter (A) (mm)
Ø 6.35	8.7 - 9.1
Ø 9.53	12.8 - 13.2
Ø 12.7	16.2 - 16.6
Ø 15.9	19.3 - 19.7
Ø 19.1	23.6 - 24.0

Figure 6.2 Flared opening

- » When connecting a flared joint, apply some compressor oil to the inner and outer surfaces of the flared opening to facilitate the connection and rotation of the flare nut, ensure firm connection between the sealing surface and the bearing surface, and avoid the pipe becoming deformed.

### 6.3.5 Bending piping

#### Piping bending methods

- » Hand bending is suitable for thin copper piping (Ø6.35mm - Ø12.7mm).
- » Mechanical bending (using a bending spring, manual bending machine or powered bending machine) is suitable for a wide range of diameters (Ø6.35mm - Ø54.0mm).

#### CAUTION!

- » When using a spring bender, ensure that the bender is clean before inserting it in the piping.
- » After bending a copper pipe, ensure that there are no wrinkles or deformation on either side of the pipe.

- » Ensure that bend angles do not exceed 90°, otherwise wrinkles may appear on the inner side of the pipe, and the pipe may buckle or crack. Refer to Figure 6.3.
- » Do not use a pipe that has buckled during the bending process; ensure that the cross section at the bend is greater than 2/3 of the original area.

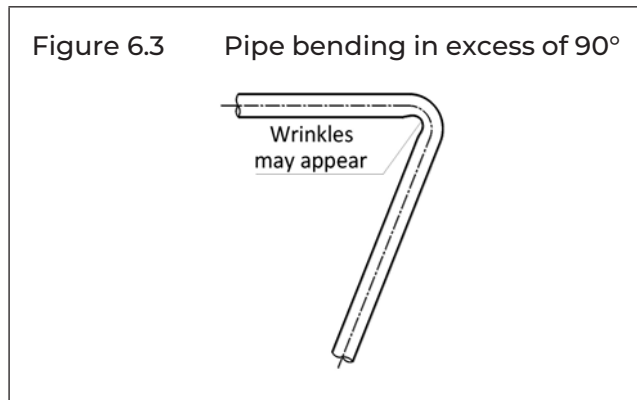

#### 6.4 Refrigerant Piping Supports

When the air conditioner is running, the refrigerant piping will deform (shrink, expand, droop). To avoid damage to piping, hangers or supports should be spaced as per the criteria in the table below. In general, the gas and liquid pipes should be suspended in parallel and the interval between support points should be selected according to the diameter of the gas pipe.

Pipe (mm)	Interval between support points (m)	
	Horizontal Piping	Vertical Piping
< Ø20	1	1.5
Ø20 – Ø40	1.5	2
> Ø40	2	2.5

Suitable insulation should be provided between the piping and the supports. If wooden dowels or blocks are to be used, use wood that has undergone preservative treatment.

Changes in refrigerant flow direction and refrigerant temperature result in movement, expansion and shrinkage of the refrigerant piping. Piping should therefore not be fixed too tightly, otherwise stress concentrations may occur in the piping, with the potential for rupturing.

#### 6.5 Brazing

Care must be taken to prevent oxide forming on the inside of copper piping during brazing. The presence of oxide in a refrigerant system adversely affects the operation of valves and compressors, potentially leading to low efficiency or even compressor failure. To prevent oxidation, during brazing nitrogen should be flowed through the refrigerant piping.

#### CAUTION!

- » Never flow oxygen through piping as doing so aids oxidation and could easily lead to explosion and as such is extremely dangerous.
- » Take appropriate safety precautions such as having a fire extinguisher to hand

whilst brazing.

### Flowing nitrogen during brazing

- » Use a pressure reducing valve to flow nitrogen through copper piping at 0.02-0.03MPa during brazing.
- » Start the flow before brazing starts and ensure that the nitrogen continuously passes through the section being brazed until the brazing is complete and the copper has cooled down completely.

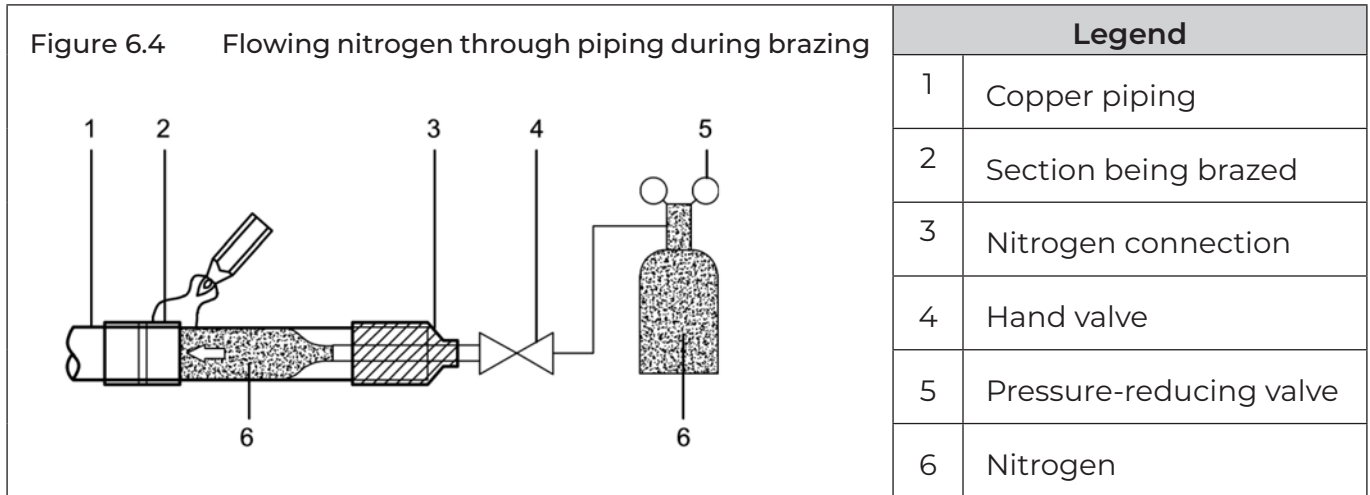

- » When joining a shorter section of piping to a longer section, flow nitrogen from the shorter side to allow better displacement of air with nitrogen.
- » If the distance from the point where nitrogen enters the piping to the joint to be brazed is long, ensure that the nitrogen is flowed for sufficient time to discharge all the air from the section to be brazed before commencing brazing.

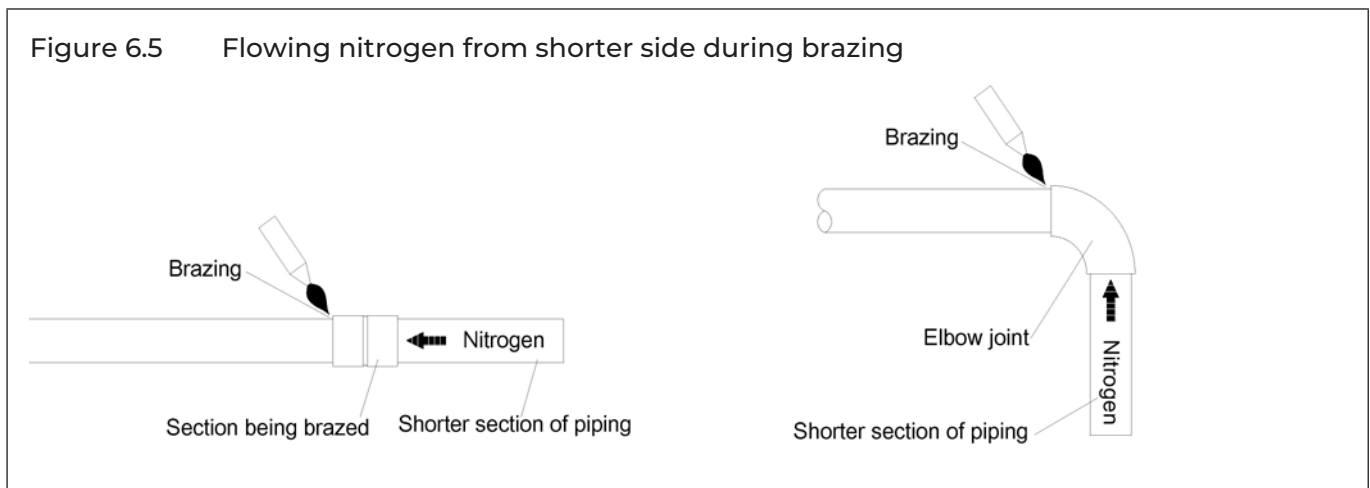

### Piping orientation during brazing

Brazing should be conducted downwards or horizontally to avoid filler leakage.

Figure 6.6 Piping orientation during brazing

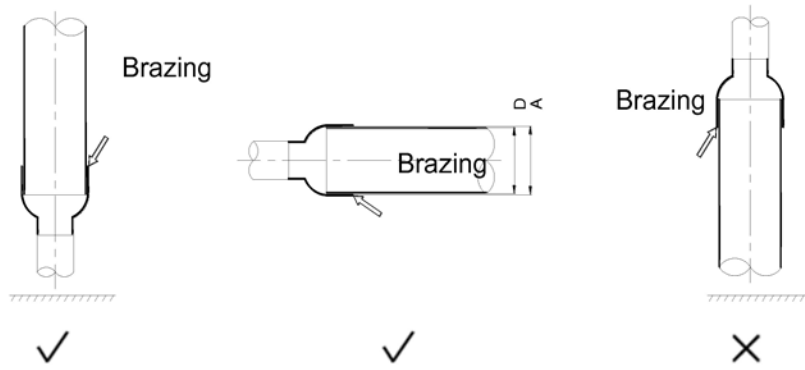

### Piping overlap during brazing

The table below specifies the minimum permissible piping overlap and the range of permissible gap sizes for brazed joints on piping of different diameters. Refer also to Figure 6.7.

D (mm)	Minimum permissible B (mm)	Permissible A – D (mm)
5 < D < 8	6	0.05 - 0.21
8 < D < 12	7	
12 < D < 16	8	0.05 - 0.27
16 < D < 25	10	
25 < D < 35	12	0.05 - 0.35
35 < D < 45	14	

Figure 6.7 Piping overlap and gap for brazed joints

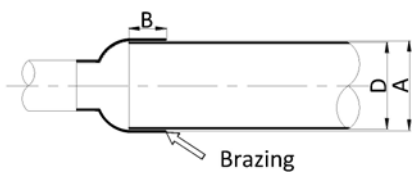

#### Legend

A	Inner diameter of larger pipe
D	Outer diameter of smaller pipe
B	Inlaid depth (overlap)

### Filler

- » Use a copper/phosphorus brazing alloy (BCuP) filler that does not require flux.
- » Do not use flux. Flux can cause corrosion of piping and can affect the performance of compressor oil.
- » Do not use anti-oxidants when brazing. Residue can clog piping and damage components.

## 6.6 Pipe Flushing

### 6.6.1 Purpose

To remove dust, other particles and moisture, which could cause compressor malfunction if not flushed out before the system is run, the refrigerant piping should be flushed using nitrogen. As described in 6.1.1 "Installation procedure", pipe flushing should be performed once the piping connections have been completed with the exception of the final connections to the indoor units. That is, flushing should be

performed once the outdoor units have been connected but before the indoor units are connected.

### 6.6.2 Procedure

#### CAUTION!

Only use nitrogen for flushing. Using carbon dioxide risks leaving condensation in the piping. Oxygen, air, refrigerant, flammable gases and toxic gases must not be used for flushing. Use of such gases may result in fire or explosion.

EN

#### Procedure

The liquid and gas sides can be flushed simultaneously; alternatively, one side can be flushed first and then Steps 1 to 8 repeated, for the other side. The flushing procedure is as follows:

1. Cover the inlets and outlets of the indoor units to prevent dirt getting blown in during pipe flushing. (Pipe flushing should be carried out before connecting the indoor units to the piping system.)
2. Attach a pressure reducing valve to a nitrogen cylinder.
3. Connect the pressure reducing valve outlet to the inlet on the liquid (or gas) side of the outdoor unit.
4. Start to open the nitrogen cylinder valve and gradually increase the pressure to 0.5MPa.
5. Allow time for nitrogen to flow as far as the opening at indoor unit A.
6. Flush the first opening:
  - a. Using suitable material, such as a bag or cloth, press firmly against the opening at indoor unit A.
  - b. When the pressure becomes too high to block with your hand, suddenly remove your hand allowing gas to rush out.
  - c. Repeatedly flush in this manner until no further dirt or moisture is emitted from the piping. Use a clean cloth to check for dirt or moisture being emitted. Seal the opening once it has been flushed.
7. Flush the other openings in the same manner, working in sequence from indoor unit A towards the outdoor unit.
8. Once flushing is complete, seal all openings to prevent dust and moisture from entering.

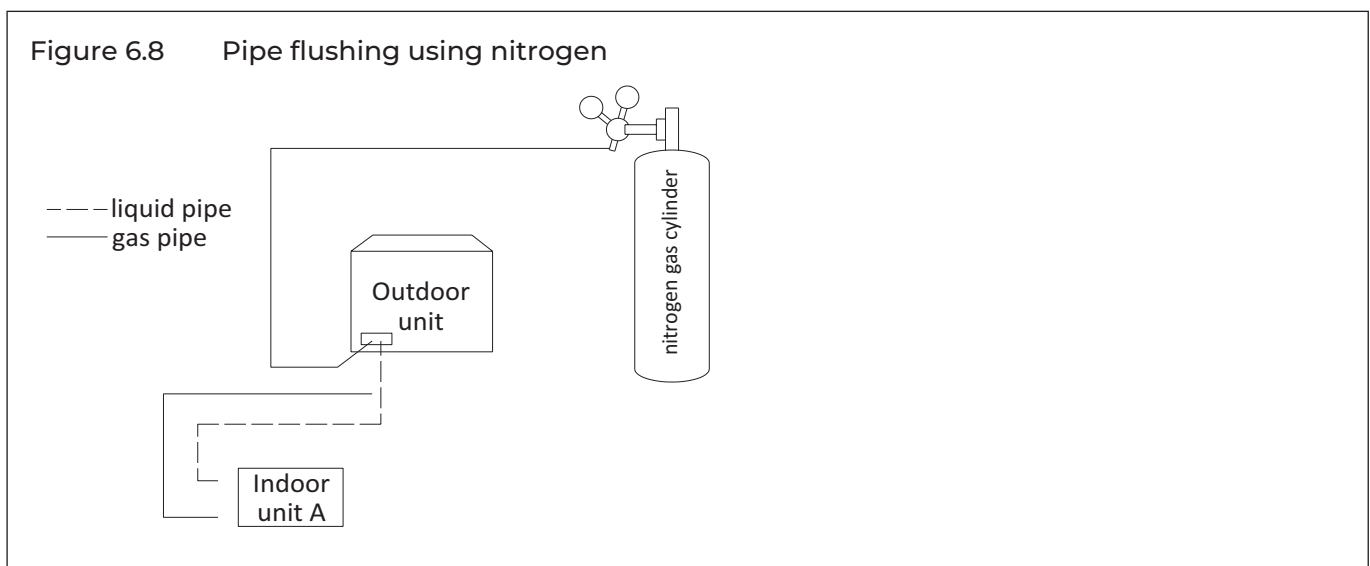

## 6.7 Gas tightness test

### 6.7.1 Purpose

To prevent faults caused by refrigerant leakage, a gas tightness test should be performed before system commissioning.

### 6.7.2 Procedure

#### CAUTION!

Only dry nitrogen should be used for gas tightness testing. Oxygen, air, flammable gases and toxic gases must not be used for gas tightness testing. Use of such gases may result in fire or explosion.

#### Procedure

The gas tightness test procedure is as follows:

##### Step 1

- » Once the piping system is complete and the indoor and outdoor units have been connected, vacuum the piping to -0.1MPa.

##### Step 2

- » Charge the indoor piping with nitrogen at 0.3MPa through the needle valves on the liquid and gas stop valves and leave for at least 3 minutes (do not open the liquid or gas stop valves). Observe the pressure gauge to check for large leakages. If there is a large leakage, the pressure gauge will drop quickly.
- » If there are no large leakages, charge the piping with nitrogen at 1.5MPa and leave for at least 3 minutes. Observe the pressure gauge to check for small leakages. If there is a small leakage, the pressure gauge will drop distinctly.
- » If there are no small leakages, charge the piping with nitrogen at 4 MPa and leave for at least 24 hours to check for micro leakages. Micro leakages are difficult to detect. To check for micro leakages, allow for any change in ambient temperature over the test period by adjusting the reference pressure by 0.01MPa per 1°C of temperature difference. Adjusted reference pressure = Pressure at pressurization + (temperature at observation – temperature at pressurization) x 0.01MPa. Compare the observed pressure with the adjusted reference pressure. If they are the same, the piping has passed the gastightness test. If the observed pressure is lower than the adjusted reference pressure, the piping has a micro leakage.
- » If the leakage is detected, refer to 6.7.3 “Leak detection”. Once the leak has been found and fixed, the gas tightness test should be repeated.

##### Step 3

- » If not continuing straight to vacuum drying (see 6.8 “Vacuum Drying”) once the gas tightness test is complete, reduce the system pressure to 0.5-0.8MPa and leave the system pressurized until ready to carry out the vacuum drying procedure.

**Figure 6.9 Gas tightness test**

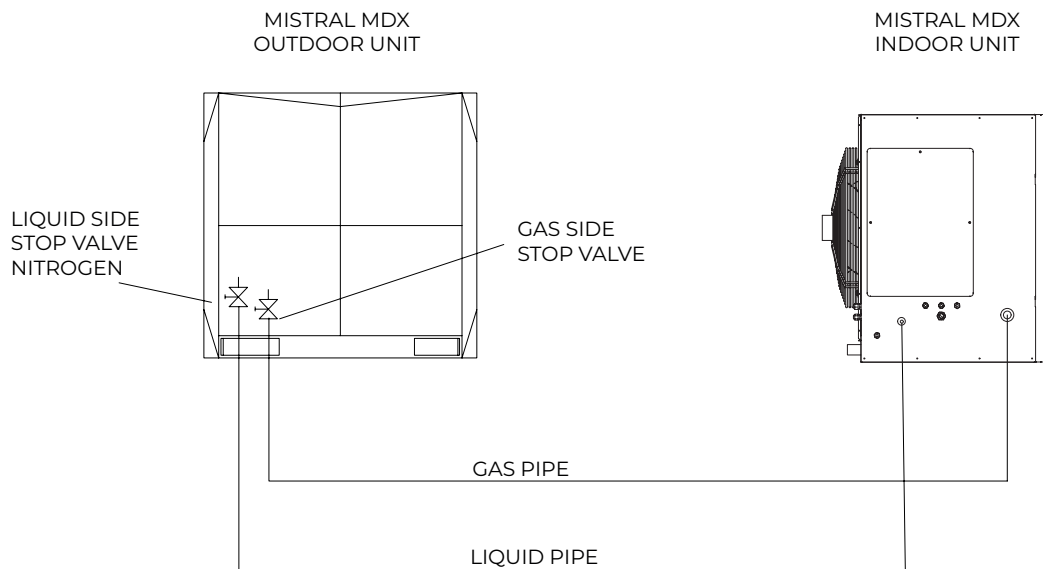

### 6.7.3 Leak detection

The general methods for identifying the source of a leak are as follows:

1. Audio detection: relatively large leaks are audible.
2. Touch detection: place your hand at joints to feel for escaping gas.
3. Soapy water detection: small leaks can be detected by the formation of bubbles when soapy water is applied to a joint.
4. Refrigerant leak detection: for leaks that are difficult to detect, refrigerant leak detection may be used as follows:
  - a. Pressurize the piping with nitrogen at 0.3MPa.
  - b. Add refrigerant into the piping until the pressure reaches 0.5MPa.
  - c. Use a halogen refrigerant detector to find the leak.
  - d. If the leak source cannot be found, continuing charging with refrigerant to a pressure of 4MPa and then search again.

## 6.8 Vacuum Drying

### 6.8.1 Purpose

Vacuum drying should be performed in order to remove moisture and non-condensable gases from the system. Removing moisture prevents ice formation and oxidization of copper piping or other internal components. The presence of ice particles in the system would cause abnormal operation, whilst particles of oxidized copper can cause compressor damage. The presence of non-condensable gases in the system would lead to pressure fluctuations and poor heat exchange performance.

Vacuum drying also provides additional leak detection (in addition to the gas tightness test).

### 6.8.2 Procedure

During vacuum drying, a vacuum pump is used to lower the pressure in the piping to the extent that any moisture present evaporates. At 5mmHg (755mmHg below typical atmospheric pressure) the boiling point of water is 0°C. Therefore a vacuum pump

capable of maintaining a pressure of -756mmHg or lower should be used. Using a vacuum pump with a discharge in excess of 4L/s and a precision level of 0.02mmHg is recommended.

### **CAUTION!**

- » Before performing vacuum drying, make sure that all the outdoor unit stop valves are firmly closed.
- » Once the vacuum drying is complete and the vacuum pump is stopped, the low pressure in the piping could suck vacuum pump lubricant into the air conditioning system. The same could happen if the vacuum pump stops unexpectedly during the vacuum drying procedure. Mixing of pump lubricant with compressor oil could cause compressor malfunction and a one-way valve should therefore be used to prevent vacuum pump lubricant seeping into the piping system.

### **Procedure**

The vacuum drying procedure is as follows:

#### **Step 1**

- » Connect the blue (low pressure side) hose of a pressure gauge to the outdoor unit gas pipe stop valve, the red (high pressure side) hose to the outdoor unit liquid pipe stop valve and the yellow hose to the vacuum pump.

#### **Step 2**

- » Start the vacuum pump and then open the pressure gauge valves to start vacuum the system.
- » After 30 minutes, close the pressure gauge valves.
- » After a further 5 to 10 minutes check the pressure gauge. If the gauge has returned to zero, check for leakages in the refrigerant piping.

#### **Step 3**

- » Re-open the pressure gauge valves and continue vacuum drying for at least 2 hours and until a pressure difference of 756mmHg or more has been achieved. Once the pressure difference of at least 756mmHg has been achieved, continue vacuum drying for 2 hours.

#### **Step 4**

- » Close the pressure gauge valves and then stop the vacuum pump.
- » After 1 hour, check the pressure gauge. If the pressure in the piping has not increased, the procedure is finished. If the pressure has increased, check for leakages.
- » After vacuum drying, keep the blue and red hoses connected to the pressure gauge and to the outdoor unit stop valves, in preparation for refrigerant charging (see Chapter 9 "Charging Refrigerant").



Figure 5.10 Vacuum drying

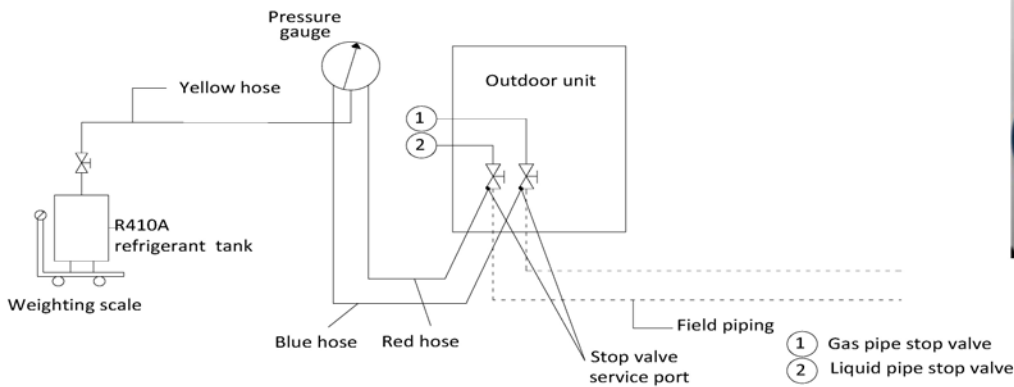

EN

## 7 Drain Piping\*

\* If the MISTRAL MDX is only used in heating mode, a condensation drain is not necessary.

### 7.1 Design Considerations

Drain piping design should take account of the following considerations:

- » Indoor unit condensate drain piping needs to be of sufficient diameter to carry the volume of condensate produced at the indoor units and installed at a slope sufficient to allow drainage. Discharge as close as possible to the indoor units is usually preferable.
- » The routing of drain piping should take into consideration the need to maintain sufficient slope for drainage whilst avoiding obstacles such as beams and ducting. The drain piping slope should be at least 1:100 away from indoor units. Refer to Figure 7.1.

Figure 7.1 Drain piping minimum slope requirement

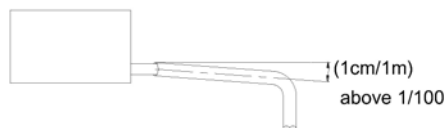

- » To avoid backflow and other potential complications, two horizontal drain pipes should not meet at the same level. Refer to the Figure 7.2 for suitable connection arrangements. Such arrangements also allow the slope of the two horizontal pipes to be selected independently.

Figure 7.2 Drain piping joints – correct and incorrect configurations

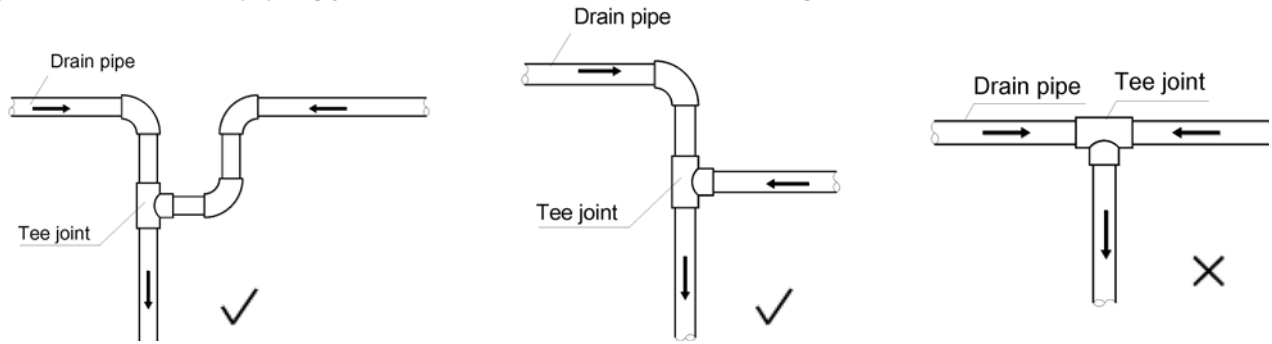

- » Branch drain piping should join main drain piping from the top, as shown in Figure 7.3. Recommended support/hanger spacing is 0.8 – 1.0m for horizontal piping and 1.5 – 2.0m for vertical piping. Each vertical section should be fitted with at least two supports. For horizontal piping, spacing greater than those recommended leads to sagging and deformation of the pipe profile at the supports which impedes water flow and should therefore be avoided.
- » Air vents should be fitted at the highest point of each drain piping system to ensure that condensation is discharged smoothly. U-bends or elbow joints should be used such that the vents face downwards, to prevent dust entering the piping. Refer to Figure 7.5. Air vents should not be installed too close to indoor unit lift pumps.

Figure 7.3 Branch drain piping joining main drain piping

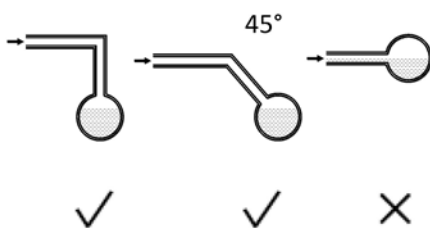
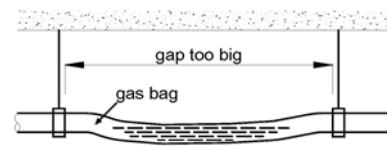

Figure 7.4 Effect of insufficient drain piping support



- » Air conditioner drain piping should be installed separately from waste, rainwater and other drain piping and should not come into direct contact with the ground.
- » Drain piping diameter should be not less than the indoor units' drain piping connection.
- » To allow inspection and maintenance, piping clamps should be used to attach drain piping to indoor units – adhesive should not be used.
- » Thermal insulation should be added to drain piping to prevent condensation forming. Thermal insulation should extend all the way to the connection with the indoor unit.
- » Units with drain pumps should have separate drain piping systems from systems that use natural drainage.

## 7.2 Water Traps

For indoor units with a high negative pressure differential at the outlet of the drainage pan, a trap should be fitted to the drain piping to prevent poor drainage and/or water being blown back into the drainage pan. Traps should be arranged as in Figure 7.5. The vertical separation H should be in excess of 50mm. A plug may be fitted to allow

cleaning or inspection.



### 7.3 Selecting Piping Diameters

Select branch drainage piping (the drain piping connection to each unit) diameters according to indoor unit flow volume and select main drainage piping diameters according to the combined flow volume of the upstream indoor units. Use a design assumption of 2 liters of condensate per horsepower per hour. For example, the combined flow volume of three 2HP units and two 1.5HP units would be calculated as follows:

$$\begin{aligned} \text{Combined flow volume} &= 3 \times 2 \text{ L/HP/h} \times 2\text{HP} = 12 \text{ L/h} \\ &+ 2 \times 2 \text{ L/HP/h} \times 1.5\text{HP} = 6 \text{ L/h} \end{aligned}$$

The tables below specify the required piping diameters for horizontal and vertical branch piping and for main piping. Note that main piping should use PVC40 or larger.

#### Horizontal drain piping diameters

PVC piping	Nominal diameter (mm)	Capacity (L/h)		Remarks
		Slope 1:50	Slope 1:100	
PVC25	25	39	27	Branch piping only
PVC32	32	70	50	
PVC40	40	125	88	Branch or main piping
PVC50	50	247	175	
PVC63	63	473	334	

#### Vertical drain piping diameters

PVC piping	Nominal diameter (mm)	Capacity (L/h)	Remarks
PVC25	25	220	Branch piping only
PVC32	32	410	
PVC40	40	730	Branch or main piping
PVC50	50	1440	
PVC63	63	2760	
PVC75	75	5710	
PVC90	90	8280	

## 7.4 Drain Piping for Units with Lift Pumps

Drain piping for units with lift pumps should take account of the following additional considerations:

- » A downward sloping section should immediately follow the vertically rising section adjacent to the unit, otherwise a water pump error will occur. Refer to Figure 7.6.
- » Air vents should not be installed on vertically rising sections of drain piping, otherwise water may be discharged through the air vent or water flow may be impeded.

Figure 7.6 Downward sloping section of drain piping

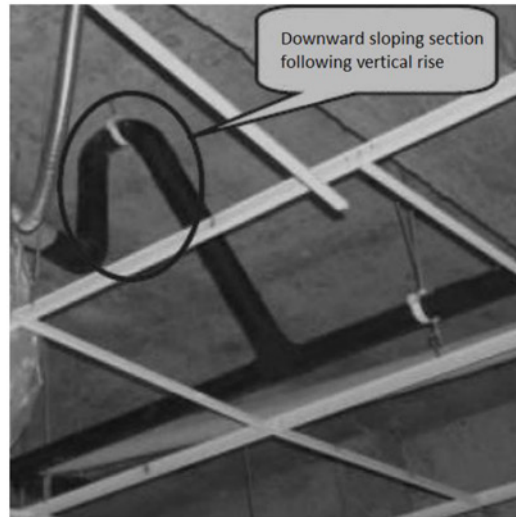

## 7.5 Drain Piping Installation

Installation of the drain piping should proceed in the following order:



### CAUTION!

- » Ensure that all joints are firm and once the drain piping is all connected, conduct a water tightness test and then a water flow test.
- » Do not connect air conditioner drain piping to waste, rainwater or other drain piping and do not let air conditioner drain piping come into direct contact with the ground.
- » For units with drain pumps, test that the drain pump functions properly by adding water to the unit's drainage pan and running the unit. To allow inspection and maintenance, pipe clamps should be used to attach drain piping to indoor units - adhesive should not be used.

## 7.6 Water tightness Test and Water Flow Test

Once installation of a drainage piping system is complete, water tightness and water flow tests should be performed.

### Water tightness test

- » Fill the piping with water and test for leakages over a 24-hour period.

**Water flow test (natural drainage test)**

- » Slowly fill the drainage pan of each indoor unit with at least 600ml of water through the inspection port and check that the water is discharged through the outlet of the drain piping.

**CAUTION!**

- » The drain plug in the drainage pan is for removing accumulated water prior to performing indoor unit maintenance. During normal operation, the drain should be plugged to prevent leakage.

## 8 Insulation

### 8.1 Refrigerant Piping Insulation

#### 8.1.1 Purpose

During operation, the temperature of the refrigerant piping varies. Insulation is required to ensure unit performance and compressor lifespan. During cooling, the gas pipe temperature can be very low. Insulation prevents condensation forming on the piping. During heating, the gas pipe temperature can rise to as high as 100°C. Insulation serves as necessary protection from burns.

#### 8.1.2 Selecting insulation materials

Refrigerant piping insulation should be closed-cell foam of B1 fire resistance rating that can withstand a constant temperature of over 120°C and that complies with all applicable legislation.

#### 8.1.3 Thickness of insulation

Minimum thicknesses for refrigerant piping insulation are specified in the table below. In hot, humid environments, the thickness of insulation should be increased over and above the specifications in the table.

Pipe outer diameter (mm)	Minimum insulation thickness (mm) Humidity < 80%RH	Minimum insulation thickness (mm) Humidity > 80%RH
Ø 6.35	15	20
Ø 9.53		
Ø 12.7		
Ø 15.9		
Ø 19.1		
Ø 22.2		
Ø 25.4		
Ø 28.6		
Ø 31.8		
Ø 41.3	20	25
Ø 44.5		
Ø 54.0		

### 8.1.4 Installation of piping insulation

With the exception of joint insulation, insulation should be applied to piping before fixing the piping in place. Insulation at joints in refrigerant piping should be applied after the gas tightness test has been completed.

- » Installation of insulation should be carried out in a manner suited to the type of insulation material being used.
- » Ensure there are no gaps at the joints between sections of insulation.
- » Do not apply tape too tightly as doing so may shrink insulation, reducing its insulating properties leading to condensation and loss of efficiency.
- » Insulate gas and liquid pipes separately, otherwise heat exchange between the two sides will greatly impact efficiency.
- » Do not bind the separately insulated gas and liquid pipes together too tightly as doing so can damage the joints between sections of insulation.

### 8.1.5 Installation of joint insulation

Insulation at joints in the refrigerant piping should be installed after the gas tightness test has been successfully completed. The procedure at each joint is as follows:

1. Cut a section of insulation 50 to 100mm longer than the gap to be filled. Ensure that the cross-sectional and longitudinal openings are all cut evenly.
2. Embed the section into the gap ensuring that the ends abut tightly to the sections of insulation either side of the gap
3. Glue the longitudinal cut and the joints with the sections of insulation either side of the gap.
4. Seal the seams with tape.

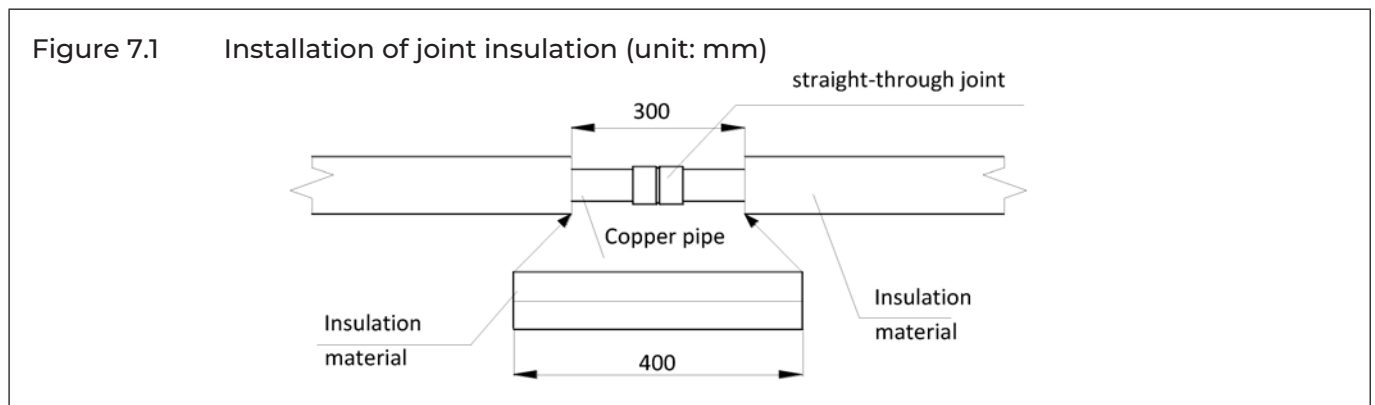

## 8.2 Drain Piping Insulation

- » Use rubber/plastic insulating tube with a B1 fire resistance rating.
- » The insulation should typically be in excess of 10mm thick.
- » For drain piping installed inside a wall, insulation is not required.
- » Use suitable adhesive to seal seams and joints in the insulation and then bind with cloth reinforced tape of width not less than 50mm. Ensure tape is fixed firmly to avoid condensation.
- » Ensure the drain piping insulation adjacent to the indoor unit drainage water outlet is fixed to the unit itself using adhesive, to prevent condensation and dripping.

### 8.3 Ducting Insulation

- » Suitable insulation should be added to ducting in according with all applicable legislation.

## 9 Charging Refrigerant

### 9.1 Calculating Additional Refrigerant Charge

The additional refrigerant charge required depends on the lengths and diameters of the outdoor and indoor liquid pipes. The table below shows the additional refrigerant charge required per meter of equivalent pipe length for different diameters of pipe. The total additional refrigerant charge is obtained by summing the additional charge requirements for each of the outdoor and indoor liquid pipes, as in the following formula, where L1 to L8 represent the equivalent lengths of the pipes of different diameters.

Liquid side piping (mm)	Additional refrigerant charge per meter of equivalent length of piping (kg)
Ø 15.9	0.170

### 9.2 Additional Refrigerant Charge for each Outdoor Unit Model

The additional refrigerant charge also depends on Outdoor Unit Model, as shown in the table below.

Type	Additional refrigerant charge per model (kg)
MDX 56	5.2

### 9.3 Adding Refrigerant

#### CAUTION!

- » Only charge refrigerant after performing a gas tightness test and vacuum drying.
- » Never charge more refrigerant than required as doing so can lead to liquid hammering.
- » Only use refrigerant R410A - charging with an unsuitable substance may cause explosions or accidents.
- » Use tools and equipment designed for use with R410A to ensure required pressure resistance and to prevent foreign materials from entering the system.
- » Refrigerant must be treated in accordance with applicable legislation.
- » Always use protective gloves and protect your eyes when charging refrigerant.
- » Open refrigerant containers slowly.

#### Procedure

The procedure for adding refrigerant is as follows:

##### Step 1

- » Calculate additional refrigerant charge R (kg) (see 9.1 “Calculating Additional Refrigerant Charge”)

## Step 2

- » Place a tank of R410A refrigerant on a weighing scale. Turn the tank upside down to ensure refrigerant is charged in a liquid state. (R410A is a blend of two different chemicals compounds. Charging gaseous R410A into the system could mean that the refrigerant charged is not of the correct composition).
- » After vacuum drying (see Part 6.8 “Vacuum Drying”), the blue and red pressure gauge hoses should still be connected to the pressure gauge and to the master unit stop valves.
- » Connect the yellow hose from the pressure gauge to the R410A refrigerant tank.

## Step 3

- » Open the valve where the yellow hose meets the pressure gauge, and open the refrigerant tank slightly to let the refrigerant eliminate the air. Caution: open the tank slowly to avoid freezing your hand.
- » Set the weighting scale to zero.

## Step 4

- » Open the three valves on the pressure gauge to begin charging refrigerant.
- » When the amount charged reaches R (kg), close the three valves. If the amount charged has not reached R (kg) but no additional refrigerant can be charged, close the three valves on the pressure gauge, run the outdoor unit in cooling mode, and then open the yellow and blue valves. Continue charging until the full R (kg) of refrigerant has been charged, then close the yellow and blue valves. Note: Before running the system, be sure to complete all the pre-commissioning checks as listed in 12.1. “Pre-commissioning Checks” and be sure to open all stop valves as running the system with the stop valves closed would damage the compressor.

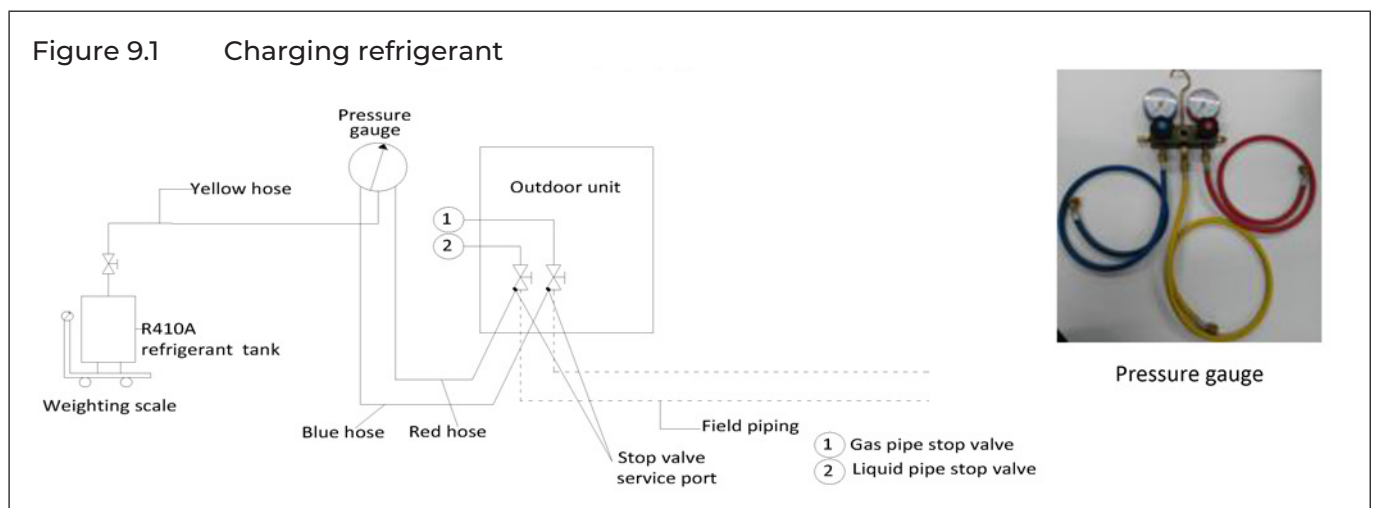

# 10 Electrical Wiring

## 10.1 General

### CAUTION!

- » All installation and wiring must be carried out by competent and suitably qualified, certified and accredited professionals and in accordance with all applicable legislation.
- » Electrical systems should be grounded in accordance with all applicable legislation.



- » Overcurrent circuit breakers and residual-current circuit breakers (ground fault circuit interrupters) should be used in accordance with all applicable legislation.
- » Wiring patterns shown in this data book are general connection guides only and are not intended for, or to include all details for, any specific installation.
- » The refrigerant piping, power wiring and communication wiring are typically run in parallel. However, the communication wiring should not be bound together with the refrigerant piping or power wiring. To prevent signal interference, the power wiring and communication wiring should not be run in the same conduit. If the power supply is less than 10A, a separation of at least 300mm between power wiring and communication wiring conduits should be maintained; if the power supply is in the range 10A to 50A then a separation of at least 500mm should be maintained.

### 10.2 Power Supply Wiring

Power supply wiring design and installation should adhere to the following requirements:

- » Separate power supplies should be provided for the indoor units and outdoor unit.
- » Installation must comply with the relevant local and/or national regulations.

### 10.3 Communication Wiring

Communication wiring design and installation should adhere to the following requirements:

- » 0.8mm<sup>2</sup> three-core shielded data cable should be used for communication wiring. Using other types of cable can lead to interference and malfunction.
- » Indoor communication wiring:
  - The P and Q communication wires should NOT be grounded.
  - The shielding nets of the communication wires should be connected together and grounded. Grounding can be achieved by connecting to the metal casing adjacent to the P Q E terminals of the outdoor unit electrical control box.

The communication wires should be connected to the outdoor unit terminals indicated in Figure 10.4 and the table below.

#### CAUTION!

Communication wiring has polarity. Care should be taken to connect the poles correctly.

Figure 10.4 Outdoor unit communication terminals

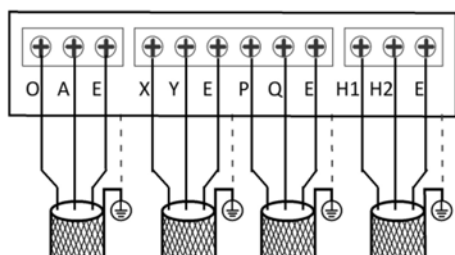

Terminals	Connection
P Q E	Connect between indoor unit and outdoor unit

## 10.4 Wiring example

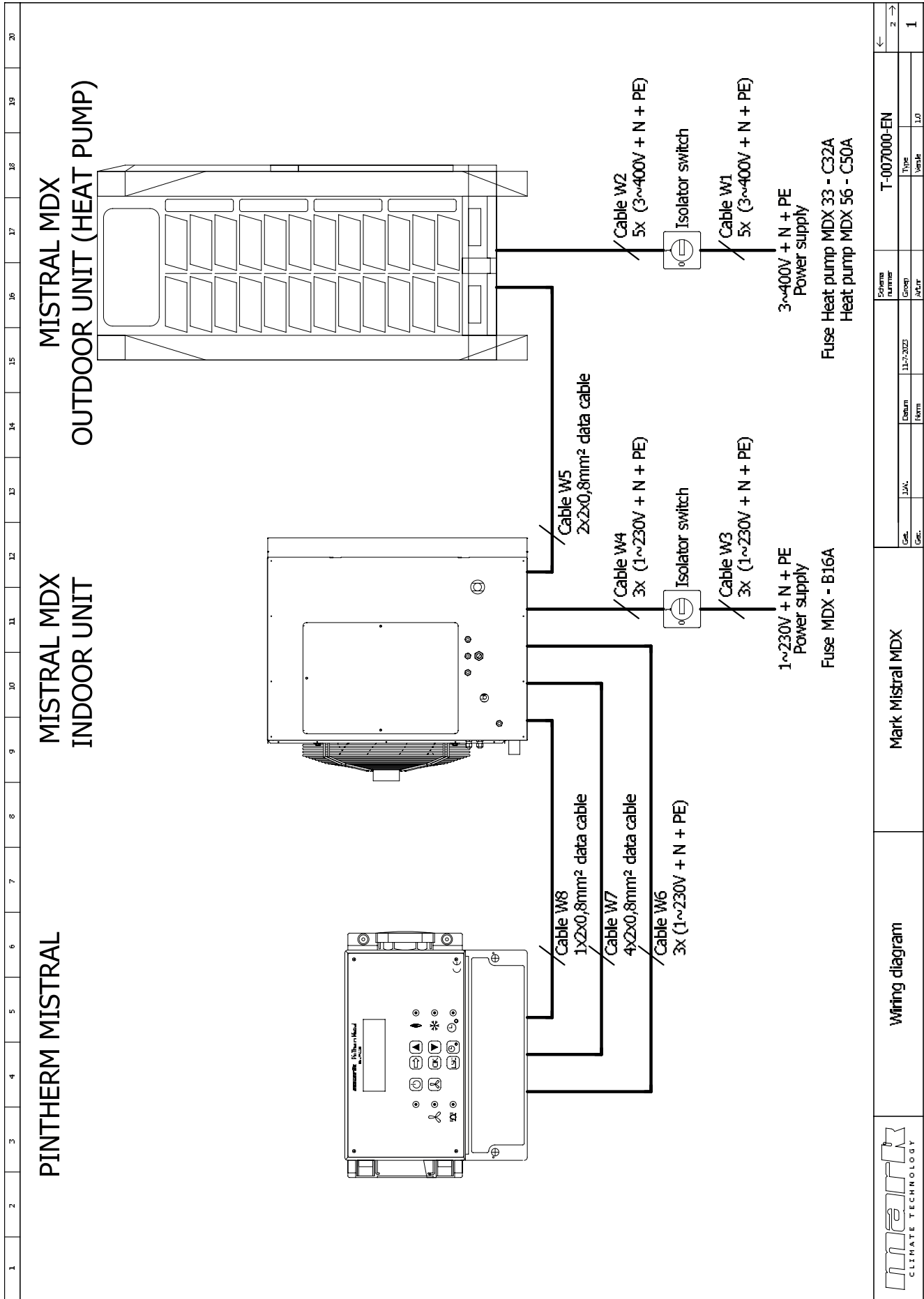

For the electrical diagram of the indoor unit, please see the technical manual of the indoor unit Mistral MDX.

# 11 Installation in Areas of High Salinity

## 11.1 Caution

Do not install outdoor units where they could be directly exposed to sea air. Corrosion, particularly on the condenser and evaporator fins, could cause product malfunction or inefficient performance.

Outdoor units installed in seaside locations should be placed such as to avoid direct exposure to the sea air and additional anticorrosion treatment options should be selected, otherwise the service life of the outdoor units will be seriously affected.

Air conditioning installed in seaside locations should be run regularly as the running of the outdoor unit fans helps prevent build-up of salt on the outdoor unit heat exchangers.

## 11.2 Placement and Installation

Outdoor units should be installed 300m or more from the sea. If possible, well-ventilated indoor locations should be chosen. (When installing outdoor units indoors, outdoor unit discharge ducts should be added. See Chapter 4 “Outdoor Unit Ducting and Shielding”.) Refer to Figure 11.1. If it is necessary to install outdoor units outside, direct exposure to the sea air should be avoided. A canopy should be added to shield the units from sea air and rain, as shown in Figure 11.2.

Ensure that base structures drain well so that outdoor unit footings do not become waterlogged. Check that outdoor unit casing drainage holes are not blocked.

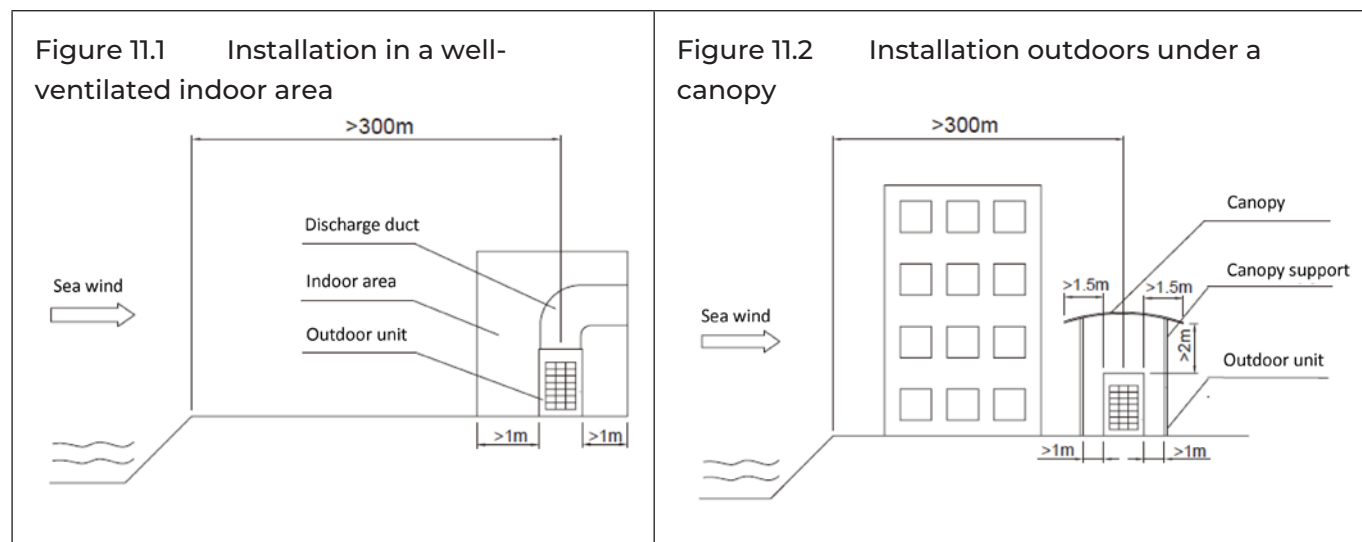

## 11.3 Inspection and maintenance

In addition to standard outdoor unit servicing and maintenance, the following additional inspections and maintenance should be undertaken for outdoor units installed in seaside locations:

- » A comprehensive post-installation inspection should check for any scratches or other damage to painted surfaces and any damaged areas should be repainted/

- repaired immediately.
- » The units should be regularly cleaned using (non-salty) water to remove any salt that has accumulated. Areas cleaned should include the condenser, the refrigerant piping system, the outside surface of the unit casing and the outside surface of the electric control box.
  - » Regular inspections should check for corrosion and if necessary corroded components should be replaced and/or anti-corrosion treatments should be added.

## 12 Commissioning

### 12.1 Pre-commissioning Checks

Before turning on the power to the indoor and outdoor units, ensure the following:































1. All indoor and outdoor refrigeration piping and communication wiring has been connected to the correct refrigeration system and the system to which each indoor and outdoor unit belongs is clearly marked on each unit or recorded in some other suitable place.
2. Pipe flushing, gas tightness testing and vacuum drying have been satisfactorily completed as per instructions.
3. All condensate drain piping is complete and a water tightness test has been satisfactorily completed.
4. All power and communication wiring is connected to the correct terminals on units and controllers. (Check that the different phases of the 3-phase power supplies have been connected to the correct terminals).
5. No wiring has been connected in a short-circuit.
6. The power supplies to indoor and outdoor units have been checked and the power supply voltages are within  $\pm 10\%$  of the rated voltages for each product.
7. All control wiring is  $0.75\text{mm}^2$  three-core shielded cable and the shielding has been grounded.
8. The additional refrigerant charge has been added as per Chapter 9 “Charging Refrigerant”. Note: In some circumstances it may be necessary to run the system in cooling mode during the refrigerant charging procedure. In such circumstances, points 1 to 8 above should be checked before running the system for the purpose of charging refrigerant and the outdoor unit liquid and gas stop valves should be opened.

























During commissioning, it is important that you:

- » Keep a supply of R410A refrigerant at hand.
- » Keep the system layout, system piping and control wiring diagrams at hand.

## 12.2 PCB Switches and Switch Settings

### 12.2.1 Outdoor unit main PCB switch settings

Switch	Setting	Switch positions <sup>1</sup>	Description	Factory setting MDX 56
S4 	Static pressure		External Static Pressure is 0Pa (default)	*
			External Static Pressure is 20Pa (customize)	
			External Static Pressure is 40Pa (customize)	
			External Static Pressure is 60Pa (customize)	
			External Static Pressure is 80Pa (customize)	
			External Static Pressure is 100Pa (customize)	
			External Static Pressure is 120Pa (customize)	
S5 	Priority mode <sup>2</sup>		Auto priority (default)	
			Cooling priority	
			VIP priority or voting priority	
			Heating only	
			Cooling only	
			Set priority mode via centralized controller	
S6-1 	Reserved		Reserved	
S6-2 	Clear indoor unit addresses		No action (default)	*
			Clear indoor unit addresses	
S6-3 	Addressing mode		Auto addressing (default)	*
			Manual addressing	
S8-1 	Reserved		Reserved	
S8-2 	Start-up time		Start-up time is 12 minutes (default)	*
			Start-up time is 7 minutes	
S8-3 	Reserved		Reserved	

 S7	Reserved		Reserved	
 S9	Reserved		Reserved	
 S13	Centralized controller	 ON 1	Use the new centralized controller (default)	*
		 ON 1	Use the old centralized controller	
 ENC2	Outdoor unit capacity <sup>3</sup>		Only 3, 4, 5, 6, 7, 8, 9, A, B, C should be selected 3: 14HP; 4: 16HP; 5: 18HP; 6: 20HP; 7: 22HP; 8: 24HP; 9: 26HP; A: 28HP; B:30HP; C:32HP	Set at 6
 ENC4	Network address		Only 0, 1, 2, 3, 4, 5, 6, 7 should be selected (default is 0)	0
 ENC3   S12	Number of indoor units	 	The number of indoor units is in the range 0-15 0-9 on ENC3 indicate 0-9 indoor units; A-F on ENC3 indicate 10-15 indoor units	1
		 	The number of indoor units is in the range 16-31 0-9 on ENC3 indicate 16-25 indoor units; A-F on ENC3 indicate 26-31 indoor units	-
		 	The number of indoor units is in the range 32-47 0-9 on ENC3 indicate 32-41 indoor units; A-F on ENC3 indicate 42-47 indoor units	-
		 	The number of indoor units is in the range 48-63 0-9 on ENC3 indicate 48-57 indoor units; A-F on ENC3 indicate 58-63 indoor units	-
		 	The number of indoor units is 64 0 on ENC3 indicate 64 indoor units	-
 ENC5	Silent mode <sup>4</sup>	0	Night silent time is 6h/10h (default)	
		1	Night silent time is 6h/12h	
		2	Night silent time is 8h/10h	
		3	Night silent time is 8h/12h	
		4	No silent mode	
		5	Silent mode 1 (only limit max. fan speed)	
		6	Silent mode 2 (only limit max. fan speed)	
		7	Silent mode 3 (only limit max. fan speed)	
		8	Super silent mode 1 (limit max. fan speed and compressor frequency)	
		9	Super silent mode 2 (limit max. fan speed and compressor frequency)	
		A	Super silent mode 3 (limit max. fan speed and compressor frequency)	
		B	Super silent mode 4 (limit max. fan speed and compressor frequency)	
F	Set silent mode via centralized controller			

Notes:

- \* Factory settings should not be changed.
- <sup>1</sup> Black denotes the switch position.
- <sup>2</sup> Refer to 14.2.1 "Priority mode setting".
- <sup>3</sup> Switch ENC2 is factory-set and its setting should not be changed.
- <sup>4</sup> Refer to 14.2.2 "Silent mode setting"

## 12.3 Modes Set on Main PCB

### 12.3.1 Priority mode setting

Priority mode can only be set on the master unit. When an indoor unit is in mode conflict with the outdoor units the unit displays the mode conflict error. The digital display on indoor main PCB will display error code E0.

### 12.3.2 Outdoor unit main PCB switch settings

There are five priority mode options:

1. **Auto priority mode (default):** In auto priority mode, the outdoor unit will operate in heating priority mode or cooling priority mode according to the outdoor ambient temperature.
  - a. When the outdoor ambient temperature is below 13°C, the outdoor units run in heating priority mode. The heating priority mode does not change until the outdoor ambient temperature is above 18°C.
  - b. When the outdoor ambient temperature is above 18°C, the outdoor units run in cooling priority mode. The cooling priority mode does not change until the outdoor ambient temperature is below 13°C.
  - c. When the outdoor unit restarts under the outdoor ambient between 13°C and 18°C, the outdoor unit runs the same priority as before the last stop.
  - d. When the outdoor unit is initial startup under outdoor ambient temperature between 13°C and 18°C, the outdoor unit runs in heating priority mode.

Figure 12.2 Auto priority mode control

Outdoor ambient temperature

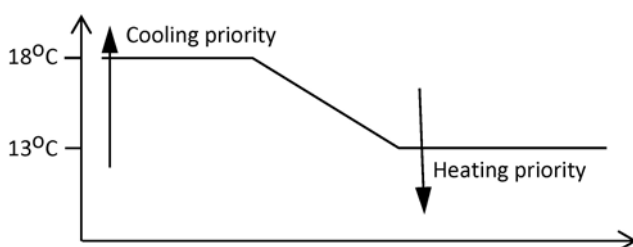

#### 1.1 Heating priority mode:

- a. During cooling operation: If an indoor unit requests heating, the outdoor unit stops and then restarts in heating mode after 5 minutes. Indoor units requesting heating then start in heating mode and indoor units requesting cooling display the mode conflict error.
- b. During heating operation: If an indoor unit requests cooling, the outdoor unit ignores the request and continues to run in heating mode. The indoor unit requesting cooling displays the mode conflict error. If all the indoor units requesting heating are later turned off and one or more indoor units are still requesting cooling, the outdoor unit restarts in cooling mode after 5 minutes and any indoor units requesting cooling then start in cooling mode.

#### 1.2 Cooling priority mode:

- a. During heating operation: If an indoor unit requests cooling, the outdoor unit stops and then restarts in cooling mode after 5 minutes. Indoor units requesting cooling then start in cooling mode and indoor units requesting heating display the mode conflict error.

b. During cooling operation: If an indoor unit requests heating, the outdoor units ignore the request and continue to run in cooling mode. The indoor unit requesting heating displays the mode conflict error. If all the indoor units requesting cooling are later turned off and one or more indoor units are still requesting heating, the outdoor unit restarts in heating mode after 5 minutes and any indoor units requesting heating then start in heating mode.

2. **Cooling priority mode:** refer to above “1.2. Cooling priority mode” descriptions.
3. **Heating only mode:** The outdoor unit only operates in heating mode. Indoor units requesting heating operate in heating mode. Indoor units requesting cooling or in fan only mode display the mode conflict error.
4. **Cooling only mode:** The outdoor unit only operates in cooling mode. Indoor units requesting cooling operate in cooling mode; indoor units in fan only mode operate in fan only mode. Indoor units requesting heating display the mode conflict error.

### 12.3.2 Silent time setting

#### 12.3.2.1 Night silent time setting

Night silent mode is activated X hours after the peak daytime temperature, and is deactivated after Y hours, where X and Y are as specified in the table below.

Switch	Switch positions	Description	X	Y
ENC5 	0	Night silent time is 6h/10h (default)	6	10
	1	Night silent time is 6h/12h	6	12
	2	Night silent time is 8h/10h	8	10
	3	Night silent time is 8h/12h	8	12

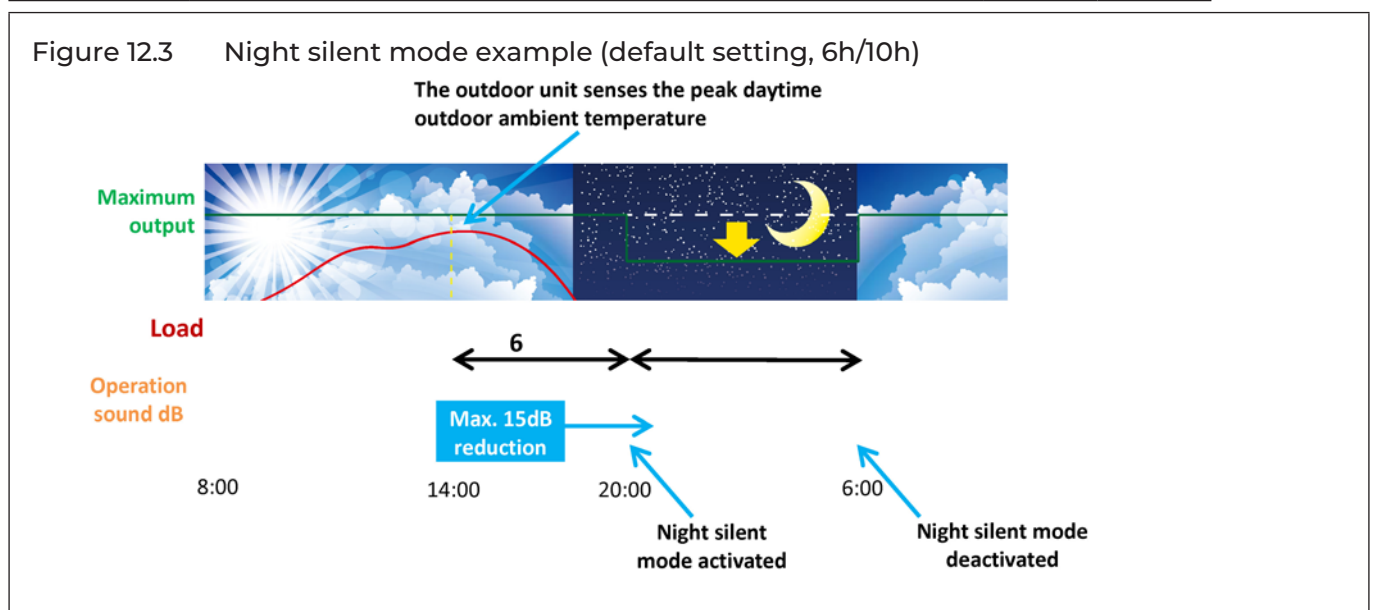



### 12.3.2.2 Silent mode setting

In silent mode 1/2/3 and night silent mode, the outdoor fan speed decreases gradually. In super silent mode 1 / 2 / 3 / 4, not only the fan speed decreases gradually, but also the compressor frequency decreases gradually.

Switch	Switch positions	Description
ENC5 	5	Silent mode 1 (only limit max. fan speed)
	6	Silent mode 2 (only limit max. fan speed)
	7	Silent mode 3 (only limit max. fan speed)
	8	Super silent mode 1 (limit max. fan speed and compressor frequency)
	9	Super silent mode 2 (limit max. fan speed and compressor frequency)
	A	Super silent mode 3 (limit max. fan speed and compressor frequency)
	B	Super silent mode 4 (limit max. fan speed and compressor frequency)

EN

### 13.2.2.3 Maximum fan speed and capacity output control in different silent mode

ENC5 Switch positions	Description	Max. fan speed index	Max. capacity output
0	Night silent time is 6h/10h (default)	22	100%
1	Night silent time is 6h/12h		
2	Night silent time is 8h/10h		
3	Night silent time is 8h/12h		
4	No silent mode		
5	Silent mode 1		
6	Silent mode 2		
7	Silent mode 3	23	
8	Super silent mode 1	22	80%
9	Super silent mode 2	21	70%
A	Super silent mode 3	20	60%
B	Super silent mode 4	19	50%

#### Notes:

If the system pressure is over 3.5MPa, the system exits silent mode automatically.

## 12.4 Commissioning Trial Runs

### 12.4.1 Commissioning test run of single refrigerant system

Once all the pre-commissioning checks in 12.1 “Pre-commissioning Checks” have been completed, a test run should be performed as described below.

Note: When running the system for commissioning test runs, if the combination ratio is 100% or less, run all the indoor units and if the combination ratio is more than 100%, run indoor units with total capacity equal to the capacity of the outdoor unit.

The test run procedure is as follows:

1. Open the outdoor unit liquid and gas stop valves.
2. Turn on the power to the outdoor unit.
3. If manual addressing is being used, set the addresses of the indoor unit.
4. Leave the power on for a minimum of 12 hours prior to running the system to ensure that the crankcase heaters have heated the compressor oil sufficiently.
5. Run the system:
  - a. Run the system in cooling mode with the following settings: temperature 17°C.
  - b. After one hour, check the system parameters using the UP/DOWN button on the outdoor unit’s main PCB.
  - c. Run the system in heating mode with the following settings: temperature 30°C.
  - d. After one hour, check the system parameters using the UP/DOWN button on the outdoor unit’s main PCB.

## 13 Error Code Table

Error code <sup>1</sup>	Content	Remarks	Manual restart
E1	Phase sequence error	Displayed on the unit with the error	Yes
E2	Communication error between indoor and outdoor units	Displayed on the unit with the error	No
E4	Outdoor heat exchanger temperature sensor (T3) error or outdoor ambient temperature sensor (T4) error	Displayed on the unit with the error	No
E5	Abnormal power supply voltage	Displayed on the unit with the error	No
E7	Compressor top or discharge pipe temperature sensor (T7Cl/2) error	Displayed on the unit with the error	Yes
E8	Outdoor unit address error	Displayed on the unit with the error	Yes
xE9	EEPROM mismatch	Displayed on the unit with the error	Yes
xF1	DC bus voltage error	Displayed on the unit with the error	No
F3	Plate heat exchanger cooling refrigerant outlet temperature sensor (T6B) error	Displayed on the unit with the error	No
F5	Plate heat exchanger cooling refrigerant inlet temperature sensor (T6A) error	Displayed on the unit with the error	No
xF6	Electronic expansion valve connection error	Displayed on the unit with the error Refer to note 3	Yes
xH0	Communication error between main control chip and inverter driver chip	Displayed on the unit with the error	No
xH4	Inverter module protection	Displayed on the unit with the error	Yes

H5	P2 protection appears three times in 60 minutes	Displayed on the unit with the error	Yes
H6	P4 protection appears three times in 100 minutes	Displayed on the unit with the error	Yes
H7	Number of indoor units detected by outdoor unit not same as number set on main PCB	Displayed on the unit with the error	No
H8	High pressure sensor error	Displayed on the unit with the error	No
H9	P9 protection appears ten times in 120 minutes	Displayed on the unit with the error	Yes
C7	PL protection appears three times in 100 minutes	Displayed on the unit with the error	Yes
P1	Discharge pipe high pressure protection	Displayed on the unit with the error	No
P2	Suction pipe low pressure protection	Displayed on the unit with the error	No
xP3	Compressor current protection	Displayed on the unit with the error	No
P4	Discharge temperature protection	Displayed on the unit with the error	No
P5	Outdoor heat exchanger temperature protection	Displayed on the unit with the error	No
P9	Fan module protection	Displayed on the unit with the error	No
PL	Inverter module temperature protection	Displayed on the unit with the error	No
PP	Compressor discharge insufficient superheat protection	Displayed on the unit with the error	No
xL0	Inverter module protection	Displayed on the unit with the error	Yes
xL1	DC bus low voltage protection	Displayed on the unit with the error	Yes
xL2	DC bus high voltage protection	Displayed on the unit with the error	Yes
xL4	MCE error	Displayed on the unit with the error	Yes
xL5	Zero speed protection	Displayed on the unit with the error	Yes
xL7	Phase sequence error	Displayed on the unit with the error	Yes
xL8	Compressor frequency variation greater than 15Hz within one second protection	Displayed on the unit with the error	Yes
xL9	Actual compressor frequency differs from target frequency by more than 1SHz protection	Displayed on the unit with the error	Yes

Notes:

<sup>1</sup> 'x' is a placeholder for the compressor system (compressor and related electrical components), with 1 representing compressor system A and 2 representing compressor system B. 'y' is a placeholder for the address (1 or 2) of the slave unit with the error.

<sup>2</sup> For some error codes, a manual restart is required before the system can resume operation.

<sup>3</sup> Once the EXV has been connected properly, the error code will flash to indicate that the connection has been re-established. A manual restart is then required before the system can resume operation.

**MARK BV**

BENEDEN VERLAAT 87-89  
VEENDAM (NEDERLAND)  
POSTBUS 13, 9640 AA VEENDAM  
TELEFOON +31(0)598 656600  
FAX +31 (0)598 624584  
info@mark.nl  
www.mark.nl

**MARK EIRE BV**

COOLEA, MACROOM  
CO. CORK  
P12 W660 (IRELAND)  
PHONE +353 (0)26 45334  
FAX +353 (0)26 45383  
sales@markeire.com  
www.markeire.com

**MARK BELGIUM b.v.b.a.**

ENERGIELAAN 12  
2950 KAPELLEN  
(BELGIË/BELGIQUE)  
TELEFOON +32 (0)3 6669254  
info@markbelgium.be  
www.markbelgium.be

**MARK DEUTSCHLAND GmbH**

MAX-PLANCK-STRASSE 16  
46446 EMMERICH AM RHEIN  
(DEUTSCHLAND)  
TELEFON +49 (0)2822 97728-0  
TELEFAX +49 (0)2822 97728-10  
info@mark.de  
www.mark.de

**MARK POLSKA Sp. z o.o**

UL. JASNOGÓRSKA 27  
42-202 CZĘSTOCHOWA (POLSKA)  
PHONE +48 34 3683443  
FAX +48 34 3683553  
info@markpolska.pl  
www.markpolska.pl

**MARK SRL ROMANIA**

STR. BANEASA NO 8 (VIA STR. LIBERTATII)  
540199 TÂRGU-MURES, JUD MURES  
(ROMANIA)  
TEL/FAX +40 (0)265-266.332  
office@markromania.ro  
www.markromania.ro

